

## Operating Manual



# COM461MT

BMS-Ethernet gateway for the connection  
of Bender devices with BMS support  
to Ethernet (TCP/IP)  
using the Modbus/TCP protocol  
Software version: D402 V1.0x



**Bender GmbH & Co. KG**

Londorfer Str. 65 • 35305 Grünberg • Germany

Postfach 1161 • 35301 Grünberg • Germany

Tel.: +49 6401 807-0

Fax: +49 6401 807-259

E-Mail: [info@bender-de.com](mailto:info@bender-de.com)

Web: <http://www.bender-de.com>

© Bender GmbH & Co. KG

All rights reserved.

Reprinting only with permission  
of the publisher.

Subject to change!

---

# Table of Contents

<b>1. Making effective use of this document</b>	<b>7</b>
1.1 How to use this manual	7
1.2 Overview of chapters	7
1.3 Quick reference guide	8
<b>2. Safety instructions</b>	<b>9</b>
2.1 Work activities on electrical installations	9
2.2 Intended use	9
2.3 Address setting and termination	10
2.4 Protection against unauthorized access	10
<b>3. Product description</b>	<b>11</b>
3.1 Scope of supply	11
3.2 A short description	11
3.3 Properties	11
3.4 Possible applications	12
<b>4. Installation, connection and commissioning</b>	<b>13</b>
4.1 Preliminary considerations	13
4.2 COM461MT on the internal BMS bus	14
4.3 Installing the device	16
4.4 Connecting the device	17
4.5 Commissioning	19
4.5.1 Determining address data	22
<b>5. The BMS-Ethernet gateway COM461MT</b>	<b>23</b>
5.1 Display and operating elements	23
<b>6. Data access using Modbus/TCP protocol</b>	<b>25</b>
6.1 Exception code	25

6.2	Modbus requests .....	26
6.3	Modbus responses .....	26
6.4	Structure of the exception code .....	27
6.5	Modbus address structure for BMS devices .....	27
<b>7.</b>	<b>Modbus process image in the memory of the COM461MT .....</b>	<b>29</b>
7.1	Requesting data .....	29
7.1.1	Modbus function code .....	29
7.1.2	How are the memory areas organised? .....	29
7.2	Memory scheme of the process image .....	30
7.2.1	BMS device address assignment on the Modbus .....	30
7.2.2	Memory scheme of an individual BMS device .....	31
7.2.3	Device name .....	33
7.2.4	Timestamp .....	34
7.2.5	C = Common alarm and D = Device lost (device failure) .....	34
7.2.6	Channels 1 to 32 With analogue and/or digital values .....	35
7.2.6.1	Float = Floating point value of the BMS channels .....	35
7.2.6.2	A&T = Alarm type and test type (internal/external) .....	36
7.2.6.3	R&U = Range and unit .....	37
7.2.6.4	Channel description .....	39
7.2.6.5	Channel 33 to 64 .....	40
7.3	Reference data records of the process image .....	41
7.3.1	Address assignment of the reference data record .....	41
7.3.2	Reference value on channel 1 .....	42
7.3.3	Reference value on channel 2 .....	43
7.3.4	Explanation of how to access floating point values .....	43
7.4	Channel descriptions for the process image .....	45
7.5	Modbus control commands .....	57
<b>8.</b>	<b>Technical data .....</b>	<b>59</b>
8.1	Tabular data .....	59
8.2	Dimension diagram .....	61
8.3	Standards, approvals, certifications .....	61

8.4	Ordering data .....	62
<b>9.</b>	<b>Troubleshooting .....</b>	<b>63</b>
9.1	Damage in transit .....	63
9.2	Malfunctions .....	63
9.2.1	What should be checked? .....	63
9.2.2	Where do you go to get help? .....	64
<b>INDEX</b>	<b>.....</b>	<b>65</b>



# 1. Making effective use of this document

## 1.1 How to use this manual

**This operating manual is aimed at qualified experts in electrical engineering and communications technology!**

To make it easier for you to understand and revisit certain sections of text and instructions in the manual, we have used symbols to identify important instructions and information. The meaning of these symbols is explained below:



---

*Information calling attention to hazards are marked with this warning symbol.*

---



---

*Information intended to assist the user to make optimum use of the product are marked with the Info symbol.*

---

## 1.2 Overview of chapters

- Making effective use of this document:  
This chapter gives you instructions on how to use this documentation
- Safety instructions:  
This chapter describes the dangers during installation and when operating the device
- Product description:  
This chapter describes the scope of delivery and features of the product

- **Installation, connection and commissioning:**  
This chapter shows the steps to take up to commissioning
- **The BMS-Ethernet gateway COM461MT:**  
This chapter describes the display and operating elements
- **Data access using Modbus/TCP protocol:**  
Describes how to send requests to the Modbus/TCP server in the COM461MT and how the responses are to be interpreted
- **Modbus process image in the COM461MT's memory:**  
In this chapter, the representation of BMS data on Modbus/TCP structures is described in detail
- **Technical data:**  
In addition to the technical data you will find here ordering data
- **Troubleshooting:**  
This chapter offers service and support in case of malfunction. In addition you will also find here information on our Technical Service department
- **Index:**  
The key word index assists you in finding the term you are searching for.

## 1.3 Quick reference guide

### Connection of the COM461MT

If you are familiar with the installation and connection of electrical devices as well as networking, particularly with Ethernet, you can start right away with the wiring diagram on page 17.

It may also be helpful to refer to block diagrams representing an application example with an internal bus on page 14.

### Using the Modbus/TCP functions

Information about this complex field can be found from page 25.



## 2. Safety instructions

### 2.1 Work activities on electrical installations

- Only skilled persons are permitted to carry out the work necessary to install, commission and run a device or system.
- Compliance with applicable regulations governing work on electrical installations, and with the regulations derived from and associated with them, is mandatory. EN 50110 is of particular importance in this regard.



---

*Any work on electrical installations which is not carried out properly can lead to death and injury!*

---

- If the device is being used in a location outside the Federal Republic of Germany, the applicable local standards and regulations must be complied with. European standard EN 50110 can be used as a guide.

### 2.2 Intended use

The BMS-Ethernet gateway COM461MT connects the serial BMS bus to Ethernet TCP/IP networks. The gateway converts alarms, measured values and statuses from the BMS bus to the Modbus/TCP protocol. This allows connection to Modbus networks.

The gateway is operated on the **internal** BMS bus.

## 2.3 Address setting and termination

In order to ensure proper functioning of the BMS-Ethernet gateway COM461MT, correct address assignment and termination of the BMS bus is of utmost importance.



---

*Assigning addresses that are already used by existing devices in the BMS or TCP/IP networks concerned may cause serious malfunctions.*

---

Ensure correct address setting and termination of the COM461MT.  
For details refer to the chapter basic configuration from page 19.

## 2.4 Protection against unauthorized access



---

***Risk of damage to equipment due to unauthorized access.***

*Attackers from the Internet may be able to read data and to change settings.*

*It is absolutely necessary to ensure that*

- the network is separated from the Internet*
  - common security mechanisms are applied (firewall, VPN access)*
-

## 3. Product description

### 3.1 Scope of supply

You will receive:

- the COM461MT
- an operating manual

### 3.2 A short description

The BMS-Ethernet gateway COM461MT contains a Modbus/TCP server that converts the BMS data for a Modbus client.

A web server makes it possible to configure the COM461MT (see “Commissioning” on page 19).

#### **Ethernet-TCP/IP interface:**

The coupling is performed via the internal Layer-2 switch. Two Ethernet ports are available.

#### **Interface on the BMS side:**

COM461MT can be operated as a master or slave.

### 3.3 Properties

- Setting of the IP address, BMS address and time/date using standard web browser
- Time synchronisation for all BMS bus devices
- Integrated Ethernet switch: 2 x RJ45, 10/100 Mbit/s
- Operation on the internal BMS bus
- Modbus/TCP data access to the internal BMS bus, max. 150 BMS devices
- Commands can be sent from an external application (e.g. data display software) to BMS devices and measured values read.

### 3.4 Possible applications

- Usage of professional data display programs by converting the BMS data to the Modbus/TCP protocol
- Observing and analysing Bender products that support communication, such as RCMS, EDS and MEDICS® systems

## 4. Installation, connection and commissioning

The BMS-Ethernet gateway is normally integrated into existing LAN structures, but can also be operated via a single PC on the Ethernet side.



---

*If you are familiar with the configuration of computer networks, you can carry out the connection of the COM461MT yourself. **Otherwise please contact your EDP administrator!***

---

### 4.1 Preliminary considerations

1. Have all the questions as regards the installation been answered by the technician responsible for the installation?
2. The device is operated on the internal BMS bus. Is the BMS address to be set known?

If, apart from the COM461MT, an alarm indicator and test combination MK800 is connected to the internal bus, the COM461MT must **not** have the address 1 (master).

You will find more detailed information on the BMS topic, in particular about the wiring of bus devices, in the separate document "BMS bus". You can download the document from the download area of the website [www.bender-de.com](http://www.bender-de.com).

3. Request network data from the technician responsible for the installation. The IP address and subnet mask are to be set manually.
4. Ask for the IP address of the NTP server, which is required for automatic time setting.
5. Are suitable PC hardware and software available for commissioning? - Minimum system requirements: 1.6-GHz processor/512 MB RAM / Windows XP/Vista/7/Web browser.

For initial connection, the basic configuration of the COM461MT is to be undertaken outside the installation, depending on the specific situation.

## 4.2 COM461MT on the internal BMS bus

Bender systems such as EDS46x/49x, RCMS46x/49x and MEDICS communicate with each other via the Bender measuring device interface BMS. The BMS-Ethernet gateway COM461MT provides the coupling between the BMS bus and TCP/IP networks. The internal Modbus/TCP server in the COM461MT communicates with the Modbus/TCP client via these networks. The following block diagram illustrates the operation of the gateway on the internal BMS bus.



---

### *Internal and external BMS bus*

*The majority of Bender devices communicate via the internal BMS bus.*

*Individual devices, such as MK800, TM 800 or Bender panels can communicate via both the internal BMS bus (BMS i) and the external BMS bus (BMS e).*

*The BMS-Ethernet gateway COM461MT can only communicate via the internal BMS bus (BMS i).*

---

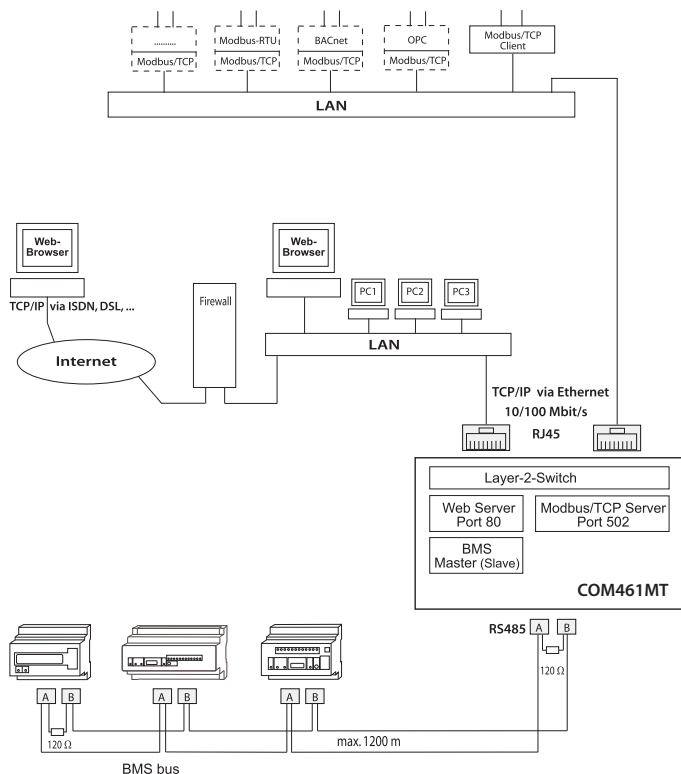

Fig. 4.1: Block diagram of a coupling between an **internal** BMS bus and TCP/IP networks

## 4.3 Installing the device

Possible methods of mounting:

- DIN rail mounting
- Screw mounting with 2 x M4 (dimension diagram on page 61)



---

*When installing the device, please take into consideration that the device is only to be used in locations that are protected from unauthorised entry!*

*This can be installation in a switch cabinet, for example.*

---



## 4.4 Connecting the device

For UL applications, the following is to be observed:

- Supply voltage  $U_s$  see nameplate and ordering data
- Maximum ambient temperature 55°C
- For use in pollution degree 2 environments
- Only 60/75 °C copper wires are to be used
- Tightening torque for terminals 0.5...0.6 Nm

Connect the terminals and sockets on the COM461MT according to the wiring diagram.

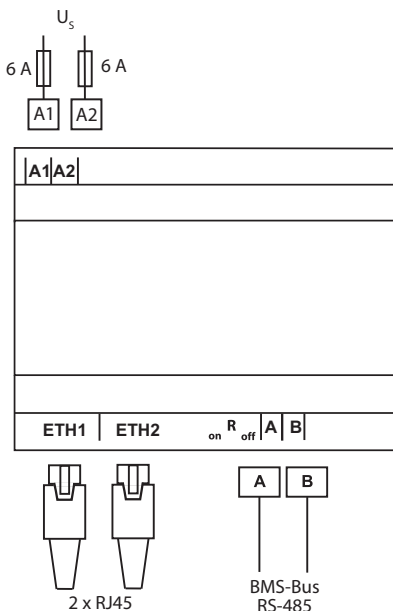

Terminal	Description
A1, A2	Connection to the supply voltage, 6 A fuse recommended, two-pole fuses should be used on IT systems. For UL and CSA applications, it is mandatory to use 5 A fuses
ETH1, ETH2	Two connections for connection to a personal computer or to the local network (hub, switch, router); Connection using a CAT5 cable; internal Layer-2 switch with cable autodetect.
A, B	Connection to the internal BMS bus with shielded cable (e.g. J-Y(St)Y 2x0.8)
R <sub>on/off</sub> (A,B)	Switch for BMS bus termination. When the device is installed at the end of the bus, set the terminating switch to "on".

## 4.5 Commissioning

1. Apply the supply voltage to the COM461MT. The green "ON" LED illuminates.
2. Connect the COM461MT to a PC and open a web browser.
3. Enter the IP address for the COM461MT (factory setting 192.168.0.254). The page for the device settings appears:

### Settings

IP address	<input type="text" value="172.16.60.64"/>
Subnet	<input type="text" value="255.255.0.0"/>
Bms address	<input type="text" value="2"/>
Modbus control	<input type="button" value="Off"/> ▼
Ntp active	<input type="button" value="Off"/> ▼
Ntp-Server address	<input type="text" value="192.168.0.123"/>
UTC	<input type="button" value="+1"/> ▼
Summertime	<input type="button" value="Off"/> ▼
Date	<input type="text" value="12/11/2012"/> mm/dd/yyyy
Time	<input type="text" value="10:17"/> hh:mm <input checked="" type="checkbox"/> skip time
<input type="button" value="Change"/> <input type="button" value="Undo"/>	
Copyright © 2011 <a href="#">BENDER Group</a> All rights reserved.	



Without address data it is not possible to access the device.

If the IP address and subnet mask are not known, this information can only be found with a large amount of effort (see "Determining address data" on page 22).

If the factory settings are changed, **always** note the modified address data in the following table.

4. Make the necessary settings. Make a note of the modified settings:

Parameter	Meaning	Factory setting	Modified setting
IP address	IP address of the COM461MT	192.168.0.254	
Subnet	Subnet mask of the COM461MT	255.255.0.0	
Bms address	Address on the internal BMS bus	2	
Modbus control	Enable or disable control via Modbus	On	
Ntp-Server address	IP address of the NTP server, is required for automatically setting the time	192.168.0.123	
UTC	Time zones setting (-12...+13): UTC + 1 h = CET UTC + 2 h = ... UTC + 3 h = ...	+1	

Parameter	Meaning	Factory setting	Modified setting
Summer-time	Select summer time setting: Off = Function disabled DST = Automatic switchover, USA, CDN CEST = Automat. switchover, Central Europe On = Set time zone + 1 h	Off	
Date	Date		
Time	Time of day		
skip time	Skip time setting. The time remains unchanged.	<input checked="" type="checkbox"/>	

- Click "Change" to save the modified settings. Or click "Undo" to undo the changes made.

### 4.5.1 Determining address data

The IP address and subnet mask set must be known for the operation of the COM461MT. If these data have been changed without making a note of the modified address data, the following options are available:

- Enter NetBIOS name in the web browser: "http://com461mt" or "com461mt" (dependent on the browser). Requirement: COM461MT and PC must lie in the same address range.
- Connect a COM460IP with option C to the network. Set address data again using COM460IP.
- Connect a COM460IP with option A to the network. Read address data using COM460IP.
- Install an IP scanner on a PC in the network and find address.
- Have COM461MT reset to the factory setting by Bender.

## 5. The BMS-Ethernet gateway COM461MT

### 5.1 Display and operating elements

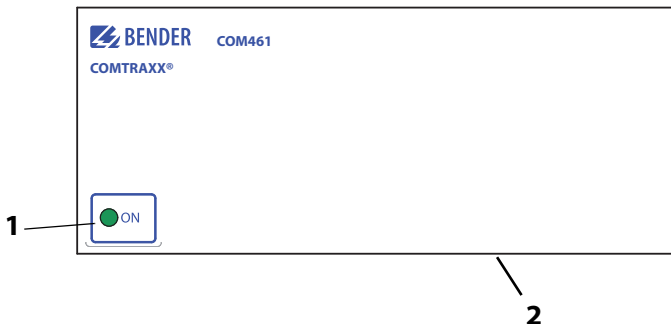

*Fig. 5.1: COM461MT front panel*

#### Key

- 1 "ON" LED lights when supply voltage is applied
- 2 Ron/off (beside terminals A, B)  
Switch for terminating the BMS bus. When the device is installed at the end of the bus, set the terminating switch to "on".





## 6. Data access using Modbus/TCP protocol

Requests are sent to the Modbus/TCP server in the COM461MT using function code FC4 (read input register). The server generates a function-related response and sends it to the Modbus client.

### 6.1 Exception code

If a request cannot be answered for whatever reason, the server sends a so-called exception code with which possible faults can be narrowed down.

Exception code	Description
0x01	Impermissible function
0x02	Impermissible data access
0x03	Impermissible data value
0x04	Slave device error
0x05	Acknowledgement of receipt (response delayed)
0x06	Request not accepted (repeat request, if necessary)
0x08	Memory: parity error
0x0A	Gateway path not available
0x0B	Gateway error

## 6.2 Modbus requests

The required words of the process image can be read from the input registers in the COM461MT using the function code FC4. For this purpose, the start address and the number of registers to be read need to be entered.

Example:

The words 0 and 1 are to be read from the input registers 0x100 and 0x101.

Byte	Name	Example
Byte 0, 1	Transaction identifier	0x0000
Byte 2, 3	Protocol identifier	0x0000
Byte 4, 5	Length field	0x0006
Byte 6	Unit identifier	0x01
Byte 7	MODBUS function code	0x04
Byte 8, 9	Device address (BMS int * 0x100)	0x0100 (corresponds to the internal BMS address 1), internal BMS bus address assignment
Byte 10, 11	Number of words	0x0002

## 6.3 Modbus responses

The responses consist of 2 bytes per register. The MSB is the first byte.

Byte	Name	Example
...	...	...
Byte 7	MODBUS function code	0x04
Byte 8	Byte count	0x04

Byte	Name	Example
Byte 9, 10	Value register 0	0x1234 (fictitious value)
Byte 11, 12	Value register 1	0x2345 (fictitious value)

## 6.4 Structure of the exception code

Byte	Name	Example
...	...	...
Byte 7	MODBUS function code	0x84
Byte 8	Exception code	0x01 or 0x02

## 6.5 Modbus address structure for BMS devices

Function	Address range	Number of bytes	Number of words
Device name	0x00...0x09	20 bytes	10 words
Timestamp	0x0A...0x0D	8 bytes	4 words
Common alarm	0x0E (high byte)	1 byte	0.5 words
No BMS bus connection	0x0E (low byte)	1 byte	0.5 words
Not used	0x0F	2 bytes	1 word
Channel 1...32	0x10...0x8F	32 x 8 bytes	128 words
Alarm and test Channel 33...64	0x90...0xFC	218 x 8 bytes	109 words



## 7. Modbus process image in the memory of the COM461MT

The device holds a process image in the memory. This image represents the current statuses and values of up to 150 BMS devices for each monitored internal BMS bus.

### 7.1 Requesting data

#### 7.1.1 Modbus function code

The memory in the COM461MT can be read using the Modbus function 4 "Read input registers". The volume of the data requested depends on the number of bytes selected in the Modbus client used. Up to 125 words (0x7D) can be read with a single request. An individual addressable byte, such as the set bit for a stored common alarm, can also be read.

#### 7.1.2 How are the memory areas organised?

Memory utilisation	Start address	End of memory area	Size of memory area
Reference values for test purposes	0x0000	0x00FF	0x0100
Process image	0x0100	0x95FF	0x9500
Not used	0x96FF	0xFFFF	0x6900



*For some Modbus clients an offset of 1 must be added to the register addresses. Example: process image start address = 0x0101.*

The assignment of the memory addresses and the associated memory content is described below.

## 7.2 Memory scheme of the process image

### 7.2.1 BMS device address assignment on the Modbus

As illustrated in the table, the Modbus start address for the respective process image is derived from the BMS device address. 256 (0x100) words or 512 bytes are reserved for each BMS device. They contain all the information requested and transmitted from the BMS bus.

Modbus address ranges of the process images in the memory				
BMS device address	Word			
	HiByte	LoByte		
		00	...	FF
1	0x01	Device 1		
2	0x02	Device 2		
3	0x03	Device 3		
...	...	...		
32	0x20	Device 32		
...	...	...		
150	0x96	Device 150		

Tab. 7.1: Modbus start address for each BMS device for which a request can be sent.

### 7.2.2 Memory scheme of an individual BMS device

BMS devices can feature various types of analogue and/or digital channels. Please take into consideration that there are device-specific differences:

- BMS devices usually feature 12 channels
- MK800/TM800 supports up to 64 digital channels in the master mode
- The channels 33 to 64 transmit digital messages only

Use the tables on page 30 and page 33 to determine the start address to request the following device parameters:

- Device name
- Timestamp
- Common alarm
- Device error
- BMS channel

Example:

In our example, data is to be requested from channel 2 of the device with BMS address 3. How is the start address determined to send the request for the channel? In our example, the relevant cells in the table are marked bold.

1. For BMS device address 3 the first part of the address, 0x03 (high byte), is taken from Table 7.1.
2. For channel 2 the second part of the address, 0x14 (low byte), is taken from Table 7.2. For the number of words to be requested the number 4 is taken from the same table: (0x14 to 0x17 = 0x04).
3. The start address 0x0314 is formed from the high byte and low byte.

Memory image of a BMS device																																		
LoByte	0	1	2	3	4	5	6	7	8	9	A	B	C	D	E	F																		
0x00	----- Device type -----										--- Timestamp ---			C	D	R.																		
0x10	Channel 1				Channel 2				Channel 3				Channel 4																					
0x20	Channel 5				Channel 6				Channel 7				Channel 8																					
0x30	Channel 9				Channel 10				Channel 11				Channel 12																					
0x40	Channel 13				Channel 14				Channel 15				Channel 16																					
0x50	Channel 17				Channel 18				Channel 19				Channel 20																					
0x60	Channel 21				Channel 22				Channel 23				Channel 24																					
0x70	Channel 25				Channel 26				Channel 27				Channel 28																					
0x80	Channel 29				Channel 30				Channel 31				Channel 32																					
0x90	33	34	35	36	37	38	39	40	41	42	43	44	45	46	47	48	49	50	51	52	53	54	55	56	57	58	59	60	61	62	63	64		
0xA0	R.	R.	R.	R.	R.	R.	R.	R.	R.	R.	R.	R.	R.	R.	R.	R.	R.	R.	R.	R.	R.	R.	R.	R.	R.	R.	R.	R.	R.	R.	R.	R.	R.	R.
0xB0	R.	R.	R.	R.	R.	R.	R.	R.	R.	R.	R.	R.	R.	R.	R.	R.	R.	R.	R.	R.	R.	R.	R.	R.	R.	R.	R.	R.	R.	R.	R.	R.	R.	R.
0xC0	R.	R.	R.	R.	R.	R.	R.	R.	R.	R.	R.	R.	R.	R.	R.	R.	R.	R.	R.	R.	R.	R.	R.	R.	R.	R.	R.	R.	R.	R.	R.	R.	R.	R.





## 7.2.4 Timestamp

Word 0x0A		0x0B		0x0C		0x0D	
HiByte	LoByte	HiByte	LoByte	HiByte	LoByte	HiByte	LoByte
Year YY		Month MM	Day DD	Hour hh	Minute mm	Second ss	Re- served

The timestamp is set according to a datagram received from a transmitting device.

## 7.2.5 C = Common alarm and D = Device lost (device failure)

Word 0x0E	
HiByte	LoByte
C	D
Common alarm, 1 byte: LSB = 0 or 1	Device error, 1 byte: LSB = 0 or 1

The common alarm bit is set as soon as an alarm status from the respective BMS device is detected.

The device error bit is set when communication with the respective BMS device is no longer possible.



### 7.2.6.2 A&T = Alarm type and test type (internal/external)

Bit	7	6	5	4	3	2	1	0	Meaning
	Test external	Test internal	Status	Reserved	Reserved	Alarm	Error		
Alarm type	X	X	X	X	X	0	0	0	No alarm
	X	X	X	X	X	0	0	1	Prewarning
	0	0	X	X	X	0	1	0	Device error
	X	X	X	X	X	0	1	1	Reserved
	X	X	X	X	X	1	0	0	Alarm (yellow LED), e.g. insulation fault
	X	X	X	X	X	1	0	1	Alarm (red LED)
	X	X	X	X	X	1	1	0	Reserved
	X	X	X	X	X	...	...	...	Reserved
	X	X	X	X	X	1	1	1	Reserved
Test	0	0	X	X	X	X	X	X	No test
	0	1	X	X	X	X	X	X	Internal test
	1	0	X	X	X	X	X	X	External test

The alarm type is coded by the bits 0 to 2. The bits 3 and 4 are reserved and always have the value 0. Bit 5 usually has the value 0 and represents the digital value of the status. This column is relevant for the SMI472 only. Bit 6 or 7 are usually set when an internal or external test has been completed. Other values are reserved. The complete byte is calculated from the sum of the alarm type and the test type.

### 7.2.6.3 R&U = Range and unit

Bit	7	6	5	4	3	2	1	0	Meaning
Unit	X	X	X	0	0	0	0	0	Invalid (init)
	X	X	X	0	0	0	0	1	No unit
	X	X	X	0	0	0	1	0	Ω
	X	X	X	0	0	0	1	1	A
	X	X	X	0	0	1	0	0	V
	X	X	X	0	0	1	0	1	%
	X	X	X	0	0	1	1	0	Hz
	X	X	X	0	0	1	1	1	Baud
	X	X	X	0	1	0	0	0	F
	X	X	X	0	1	0	0	1	H
	X	X	X	0	1	0	1	0	°C
	X	X	X	0	1	0	1	1	°F
	X	X	X	0	1	1	0	0	Second
	X	X	X	0	1	1	0	1	Minute
	X	X	X	0	1	1	1	0	Hour
	X	X	X	0	1	1	1	1	Day
	X	X	X	1	0	0	0	0	Month
	X	X	X	...	...	...	...	...	Reserved
	X	X	X	1	1	1	1	0	CODE
	X	X	X	1	1	1	1	1	Reserved
	X	X	X	...	...	...	...	...	Reserved
	X	X	X	1	1	1	1	1	Reserved

Bit	7	6	5	4	3	2	1	0	Meaning
Range of validity	0	0	X	X	X	X	X	X	True value
	0	1	X	X	X	X	X	X	True value is smaller
	1	0	X	X	X	X	X	X	True value is larger
	1	1	X	X	X	X	X	X	Invalid value

The unit is coded in the bits 0 to 4.

The bits 6 and 7 describe the range of validity of a value. Bit 5 is reserved.

The whole byte is calculated from the sum of the unit and the range of validity.

#### Caution!

If the unit byte refers to CODE, the recorded value or status will result in a text message. The content of this text message is listed in the table on page 39 or page 45. The floating point value contains an internal CODE but no valid measured value.

## 7.2.6.4 Channel description

Word	0x03																Meaning		
	Byte	HiByte								LoByte								decimal	
		Bit	15	14	13	12	11	10	9	8	7	6	5	4	3	2			1
<b>Alarms and warnings</b>																			
	0	0	0	0	0	0	0	0	0	0	0	0	0	0	0	0	0	0	Reserved
	0	0	0	0	0	0	0	0	0	0	0	0	0	0	0	0	1	1	Insulation fault
	0	0	0	0	0	0	0	0	0	0	0	0	0	0	0	0	0	2	Overload
	0	0	0	0	0	0	0	0	0	0	0	0	0	0	0	0	1	3	Overtemperature
	0	0	0	0	0	0	0	0	0	0	0	0	0	0	0	0	0	4	Failure line 1
	0	0	0	0	0	0	0	0	0	0	0	0	0	0	0	0	1	5	Failure line 2
	0	0	0	0	0	0	0	0	0	0	0	0	0	0	0	0	0	6	Insulation OP light
	0	0	0	0	0	0	0	0	0	0	0	0	0	0	0	0	1	7	Reserved
	0	0	0	0	0	0	0	0	0	0	0	0	0	0	0	0	0	8	Failure distribution board
	0	0	0	0	0	0	0	0	0	0	0	0	0	0	0	0	1	9	Oxygen
	0	0	0	0	0	0	0	0	0	0	0	0	0	0	0	0	0	10	Vacuum
	0	0	0	0	0	0	0	0	0	0	0	0	0	0	0	0	1	11	Anaesthetic gas
	0	0	0	0	0	0	0	0	0	0	0	0	0	0	0	0	0	12	Compressed air 5 bar
	...	...	...	...	...	...	...	...	...	...	...	...	...	...	...	...	...	...	...

A code with the associated descriptive text is available for each channel. The table above only shows an extract from the texts. For a complete list of the available codes or texts refer to page 45.

### 7.2.6.5 Channel 33 to 64

Bit	7	6	5	4	3	2	1	0	Meaning
	Test external	Test internal	Status	Reserved	Reserved	Alarm	Error		
Alarm type	X	X	X	X	X	0	0	0	No alarm
	X	X	X	X	X	0	0	1	Prewarning
	0	0	0	X	X	0	1	0	Device error
	X	X	X	X	X	0	1	1	Reserved
	X	X	X	X	X	1	0	0	Alarm (yellow LED), e.g. insulation fault
	X	X	X	X	X	1	0	1	Alarm (red LED)
	X	X	X	X	X	1	1	0	Reserved
	X	X	X	X	X	...	...	...	Reserved
	X	X	X	X	X	1	1	1	Reserved
Test	0	0	X	X	X	X	X	X	No test
	0	1	X	X	X	X	X	X	Internal test
	1	0	X	X	X	X	X	X	External test

The BMS channels 33 to 64 only provide digital information. The information is coded as an alarm or message type or test type (internal, external).

The coding is similar to the data format AT&T for the channels 1 to 32, with the exception of the additional bit 4, which is used for coding device errors, e.g. connection faults or internal device errors.



## 7.3 Reference data records of the process image

To make it easier to check the configuration and the Modbus/TCP data access to BMS devices, COM461MT provides a reference data record at the **virtual** BMS address 0.



*A real BMS device cannot have BMS address 0!  
Address 0 only serves to simulate data access.*

Special features of the Modbus communication are the byte offset and the word and byte order in the memory (Big Endian). At the end of this chapter, a few examples of correct configuration are given, which might be helpful.

### 7.3.1 Address assignment of the reference data record

As shown in the following table, the Modbus start address for access to the reference data record is derived from BMS device address 0.

Modbus addresses for reference data record					
Virtual BMS device address	Word	LoByte			
		00	0E	10	14
0	HiByte 0x00	Device type	Common alarm	Channel 1	Channel 2

*Tab. 7.3: Start addresses for the reference data record request*

The start addresses provide the following reference values:

- 0x0000: TEST (device type)
- 0x000E: 1 (common alarm, LSB of the high byte is set)
- 0x0010: 230 V undervoltage (reference value on channel 1)
- 0x0014: 12.34 A overcurrent (reference value on channel 2)

### 7.3.2 Reference value on channel 1

The following reference value is stored in this channel: 230.0 V undervoltage

Word 0x10		0x11		0x12		0x13	
HiByte	LoByte	HiByte	LoByte	HiByte	LoByte	HiByte	LoByte
0x43	0x66	0x00	0x00	0x00	0x04	0x00	0x4D
Floating point value (Float)				AT&T	R&U	Description	
230.0				No/No	Volt	Undervoltage	

Tab. 7.4: Reference data stored in channel 1

### 7.3.3 Reference value on channel 2

The following reference value is stored in this channel: 12.34 A

Word 0x14		0x15		0x16		0x17	
HiByte	LoByte	HiByte	LoByte	HiByte	LoByte	HiByte	LoByte
0x41	0x45	0x70	0xA4	0x00	0x03	0x00	0x4A
Floating point value (Float)				AT&T	R&U	Description	
12.34				No/No	Ampere	Overcurrent	

Tab. 7.5: Reference data stored in channel 2

### 7.3.4 Explanation of how to access floating point values

The test value 12.34 can be read out via Modbus/TCP using Modbus function 4 at the address 0x0014. The test value has a size of 2 words.

Proceed as follows:

1. Determine the correct byte offset  
 Interpreting both words as unsigned integer values should result in the following values:  
 Word 1 with address 0x14: unsigned integer value => 16709 (0x4145)  
 Word 2 with address 0x15: unsigned integer value => 28836 (0x70A4)
2. Determine the correct byte or word swap  
 There are four different combinations of swapping. The only correct value is 12.34.  
 All swapping combinations are represented in the following table.

Hex value sequence	Word 1		Word 2		Floating point value
	Byte 1	Byte 2	Byte 3	Byte 4	
CORRECT	A 41	B 45	C 70	D A4	12.34
Word swapping	C 70	D A4	A 41	B 45	4.066E+29
Byte swapping	B 45	A 41	D A4	C 70	3098.27
Word and byte swapping	D A4	C 70	B 45	A 41	-5.21E-17

## 7.4 Channel descriptions for the process image

Value	Measured value, description alarm message, operating message	Note
0		
1 (0x01)	Insulation fault	
2 (0x02)	Overload	
3 (0x03)	Overtemperature	
4 (0x04)	Failure line 1	
5 (0x05)	Failure line 2	
6 (0x06)	Insul. fault OP light	Insulation fault operating theatre light
7 (0x07)		
8 (0x08)	Failure distribution board	
9 (0x09)	Failure oxygen	
10 (0x0A)	Failure vacuum	
11 (0x0B)	Anaesthetic gas	
12 (0x0C)	Compressed air 5 bar	
13 (0x0D)	Compressed air 10 bar	

<b>Value</b>	<b>Measured value, description alarm message, operating message</b>	<b>Note</b>
14 (0x0E)	Failure nitrogen	
15 (0x0F)	Failure CO2	
16 (0x10)	Insulation UPS	Insulation fault UPS
17 (0x11)	Overload UPS	
18 (0x12)	Converter UPS	
19 (0x13)	UPS fault	
20 (0x14)	UPS emergency operation	
21 (0x15)	UPS test run	
22 (0x16)	Failure air conditioning	
23 (0x17)	Batt.op. OP-L	Battery operated operating theatre light
24 (0x18)	Batt.op. OP-S	Battery operated Sat OP light
25 (0x19)	Fail.norm.supply	Failure normal power supply
26 (0x1A)	Fail.safet.supply	Failure safety power supply

<b>Value</b>	<b>Measured value, description alarm message, operating message</b>	<b>Note</b>
27 (0x1B)	Failure UPS	Failure additional power supply
28 (0x1C)	Ins.safety supply	
29 (0x1D)	Fail.N conductor	
30 (0x1E)	Short distr.panel	Short-circuit distribution panel
31 (0x1F)		
32 (0x20)		
33 (0x21)		
34 (0x22)		
35 (0x23)	Standby function	(Measuring function switched off (standby))
36 (0x24)		
37 (0x25)		
38 (0x26)	Batt.op. UPS	Battery operation, special safety power supply
39 (0x27)	Phase sequ. left	

<b>Value</b>	<b>Measured value, description alarm message, operating message</b>	<b>Note</b>
40 (0x28)	Failure UPS	Battery supported safety power supply
41 (0x29)		
66 (0x42)		
67 (0x43)	Function test by:	Date
68 (0x44)	Service by:	Date
69 (0x45)	Ins.fault locat	Insulation fault location
70 (0x46)	Peak	Fault EDS system
71 (0x47)	Insulation fault	Insulation resistance in $\Omega$
72 (0x48)	Current	Measured value in A
73 (0x49)	Undercurrent	
74 (0x4A)	Overcurrent	
75 (0x4B)	Residual current	Measured value in A
76 (0x4C)	Voltage	Measured value in V



<b>Value</b>	<b>Measured value, description alarm message, operating message</b>	<b>Note</b>
77 (0x4D)	Undervoltage	
78 (0x4E)	Overvoltage	
79 (0x4F)	Frequency	Measured value in Hz
80 (0x50)		
81 (0x51)	Asymmetry	
82 (0x52)	Capacitance	Measured value in F
83 (0x53)	Temperature	Measured value in °C
84 (0x54)	Overload	Measured value in %
85 (0x55)	Digital input	State 0 or 1
86 (0x56)	Insulation fault	Impedance
87 (0x57)	Insulation fault	Alarm from an insulation fault locator
88 (0x58)	Load	Measured value in %
89 (0x59)	Total Hazard Current	THC
90 (0x5A)	Inductance	Measured value in H

<b>Value</b>	<b>Measured value, description alarm message, operating message</b>	<b>Note</b>
97 (0x61)	Service code	Information about service intervals
101 (0x65)	Mains power connection	
102 (0x66)	Earth connection	
103 (0x67)	Short CT	CT short-circuit
104 (0x68)	No CT connected	
105 (0x69)	Short temp.sensor	Short-circuit temperature sensor
106 (0x6A)	Temp.sensor open.	Connection temperature sensor
107 (0x6B)	K1	Fault contactor K1
108 (0x6C)	K2	Fault contactor K2
109 (0x6D)		

<b>Value</b>	<b>Measured value, description alarm message, operating message</b>	<b>Note</b>
110 (0x6E)		
111 (0x6F)	No address:	Failure BMS device
112 (0x70)		
113 (0x71)	Failure K1/Q1	Failure contactor K1/Q1
114 (0x72)	Failure K2/Q2	Failure contactor K2/Q2
115 (0x73)	Device error	Fault ISOMETER
116 (0x74)	Manual mode	K1/2 manual mode
117 (0x75)	Open circuit K1on	Line to K1 on interrupted
118 (0x76)	Open circ. K1off	Line to K1 off interrupted
119 (0x77)	Open circuit K2 on	Line to K2 on interrupted
120 (0x78)	Open circ. K2 off	Line to K2 off interrupted
121 (0x79)	K/Q1on	Fault
122 (0x7A)	K/Q1off	Fault
123 (0x7B)	K/Q2on	Fault
124 (0x7C)	K/Q2off	Fault
125 (0x7D)	Failure K3	

<b>Value</b>	<b>Measured value, description alarm message, operating message</b>	<b>Note</b>
126 (0x7E)	Q1	Fault
127 (0x7F)	Q2	Fault
128 (0x80)	No Master	
129 (0x81)	Device error	
130 (0x82)		
131 (0x83)	Fault RS-485	
132 (0x84)		
133 (0x85)		
134 (0x86)		
135 (0x87)		
136 (0x88)		
137 (0x89)	Short-circuit Q1	
138 (0x8A)	Short-circuit Q2	
139 (0x8B)	CV460	CV460 fault
140 (0x8C)	RK4xx	Fault RK4xx

Value	Measured value, description alarm message, operating message	Note
141 (0x8D)	Address collision	BMS address has been assigned several times
142 (0x8E)	Invalid address	
143 (0x8F)	Several masters	
144 (0x90)	No menu access	
145 (0x91)	Own address	
201 (0xC9)	Line 1 normal op	
202 (0xCA)	Line 2 normal op	
203 (0xCB)	Switch. el. 1 on	
204 (0xCC)	Switch. el. 2 on	
205 (0xCD)		
206 (0xCE)	Auto mode	
207 (0xCF)	Manual mode	
208 (0xD0)		

<b>Value</b>	<b>Measured value, description alarm message, operating message</b>	<b>Note</b>
209 (0xD1)		
210 (0xD2)	Line AV on	
211 (0xD3)	Line SV on	
212 (0xD4)	Line UPS on	
213 (0xD5)	Channel disabled	
214 (0xD6)	SwitchBackLock	Switching back interlocking function active
215 (0xD7)	Phase sequ. right	
216 (0xD8)	Switch. el. pos.0	
217 (0xD9)	Line BSV on	
218 (0xDA)	On	SMO48x: Alarm, relay

To convert the data of parameters, you will need data type descriptions. Text representation is not necessary in this case.

Value	Description of parameters:
1023 (0x3FF)	Parameter/measured value invalid. The menu item for this parameter is not displayed
1022 (0x3FE)	No measured value/no message
1021 (0x3FD)	Measured value/parameter inactive
1020 (0x3FC)	Measured value/parameter only temporarily inactive (e.g. during the transfer of a new parameter). Display in the menu "...".
1019 (0x3FB)	Parameter/measured value (unit not displayed)
1018 (0x3FA)	Parameter (code selection menu) unit not displayed
1017 (0x3F9)	String max. 18 characters (e.g. device type, - variant, ...)
1016 (0x3F8)	
1015 (0x3F7)	Time
1014 (0x3F6)	Date day
1013 (0x3F5)	Date month
1012 (0x3F4)	Date year
1011 (0x3F3)	Register address (unit not displayed)
1010 (0x3F2)	Time

Value	Description of parameters:
1009 (0x3F1)	Factor multiplication [*]
1008 (0x3F0)	Factor division [/]
1007 (0x3EF)	Baud rate



## 7.5 Modbus control commands

Commands can be sent to BMS devices by an external application (e.g. data display software).

Control via Modbus can be enabled or disabled on the "Settings" browser menu.

### Command structure

Write				Read
Word 0xFC00	0xFC01	0xFC02	0xFC03	0xFC04
External BMS bus address	Internal BMS bus address	BMS channel	Command	Status

Writing to register:

- To write use function code 0x10 "Write Multiple registers".
- Start address: 0xFC00
- Number: 4 registers
- Always set all four registers (word 0xFC00...0xFC03) at the same time. This statement also applies if individual registers remain unchanged.
- If there is no external BMS bus, enter value "1" in this register.
- If a BMS channel number is not required, enter value "0" (zero) in this register.

Reading register:

- To read use function code 0x04 "Read Input Registers".

Possible response in register "Status":

0	Busy	Command is being processed.
1	Error	An error has occurred.
2	Ready	Command has been processed successfully.

## Control commands for the internal BMS bus

Register Ext	Register Int	Register Channel	Register Command	Function
1	1-150	0	1	Test Isometer
1	1-150	0	2	Test changeover device PRC
1	1-150	0	3	Start automatic test changeover 1->2, end after time T(test)
1	1-150	0	4	Start test generator without changeover
1	1-150	0	5	Switchover to line 1
1	1-150	0	6	Switchover to line 2
1	0	0	7	RESET alarm (broadcast)
1	0	0	8	RESET alarm EDS (broadcast)
1	1-150	0	9	Buzzer off [for alarm address] (BC)
1	1-150	1-12	10	Switch on relay/ switch
1	1-150	1-12	11	Switch off relay/ switch

## 8. Technical data

( )\* = Factory setting

### 8.1 Tabular data

#### Insulation co-ordination according to IEC 60664-1

Rated voltage .....	AC 250 V
Rated impulse voltage/pollution degree .....	4 kV/3

#### Supply voltage

Supply voltage $U_s$ .....	See ordering data
Frequency range $U_s$ .....	See ordering data
Power consumption .....	See ordering data

#### LED indicators

2 x Ethernet ETH1, ETH2 act/link.....	Illuminates when connected to the network, flashes during data transmission
ON .....	Operation indicator

#### Interfaces

BMS bus internal:

Interface/protocol .....	RS-485/BMS bus internal
Operating mode .....	Master/slave (slave)*
Baudrate BMS internal .....	9.6 kBit/s
Cable length .....	$\leq 1200$ m
Cable, twisted pair, shielded, shield connected to PE .....	J-Y(St)Y 2x0.8
Connection, BMS internal .....	Terminals A, B
Terminating resistor .....	120 $\Omega$ (0.25 W)
Device address, BMS bus internal .....	1 . . . 99 (2)*

Ethernet:

Connection .....	2 x RJ45
Data rate .....	10/100 Mbit/s, autodetect
IP address .....	nnn.nnn.nnn.nnn (192.168.0.254)*
Subnet mask .....	nnn.nnn.nnn.nnn (255.255.0.0)*
Protocols .....	TCP/IP, Modbus/TCP, NTP

## General data

EMC .....	EN 61326-1
Climate classes acc. to IEC 60721:	
Stationary use .....	3K5
Transport .....	2K3
Long-term storage .....	1K4
Operating temperature .....	-10 ... +55 °C
Mechanical conditions acc. to IEC 60721:	
Stationary use .....	3M4
Transport .....	2M2
Long-term storage .....	1M3
Operating mode .....	Continuous duty
Mounting position .....	Display oriented

## Connection

Connection type .....	Screw terminals
Connection properties:	
Rigid/flexible .....	0.2 ... 4/0.2 ... 2.5 mm <sup>2</sup> (AWG 24 ... 12)
Multi-conductor connection (2 conductors with the same cross-section):	
Rigid/flexible .....	0.2 ... 1.5/0.2 ... 1.5 mm <sup>2</sup>
Stripped length .....	8 ... 9 mm
Tightening torque .....	0.5 ... 0.6 Nm
Degree of protection, internal components (IEC 60529) .....	IP30
Degree of protection, terminals (IEC 60529) .....	IP20
Type of enclosure .....	X460
Screw fixing .....	2 x M4
Snap-on mounting on a DIN rail .....	IEC 60715
Flammability class .....	UL94V-0
Software version .....	D402 V1.0x
Weight .....	≤ 310 g

( ) \* = Factory setting

## 8.2 Dimension diagram

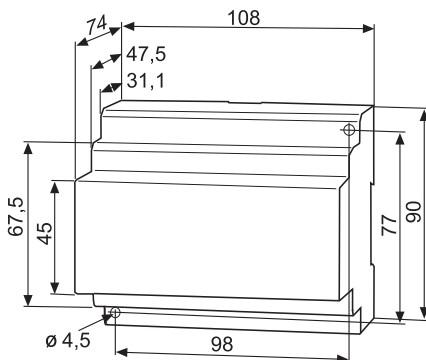

## 8.3 Standards, approvals, certifications

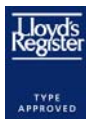



For information on UL applications refer to page 17.

### Other interface protocols

Connection to control system and/or PLC via OPC, BACnet or other protocols on request.

## 8.4 Ordering data

Type	Supply voltage/ frequency range $U_S$	Power con- sumption	 	Item no.
COM461MT BMS- Ethernet gateway	AC/DC 76...276 V */ AC 42...460 Hz/DC  For UL applications: $U_{SAC} = 76...250V,$ 40...150 mA, 42...460 Hz $U_{SDC} = 76...250V,$ 10...35 mA	3.5...40 VA/ 2.4 W	UL listed: Approval available  Lloyds register: Approval pending	B9506 1021

\*Absolute values

---

## 9. Troubleshooting

### 9.1 Damage in transit

If you find transport damage on receipt of the delivery, have this damage confirmed by the delivery agent on handover. In case of doubt, please contact:

Bender GmbH & Co.KG

Londorfer Strasse 65

35305 Gruenberg, Germany

+49 6401 807-0

### 9.2 Malfunctions

If the COM461MT causes malfunctions in the connected networks, please refer to this operating manual.

#### 9.2.1 What should be checked?

Check whether ...

- The device is supplied with the correct supply voltage
- The BMS bus cable is correctly connected and terminated (120  $\Omega$ )
- The appropriate Ethernet cable (RJ45) is correctly connected
- The BMS address is correctly set
- The IP address is correctly set
- The "Settings" page on the COM461MT web server can be opened using a web browser
- The network parameters are correctly set, as a minimum the IP address and subnet mask

## 9.2.2 Where do you go to get help?

If, despite thorough study of the technical manual and intensive troubleshooting in your installation, you cannot rectify the fault related to the BMS-Ethernet gateway COM461MT, please contact our Service department:

**Tel.: +49 6401 807-760 or 0700BENDERHELP**

**Fax: +49 6401 807-259**

**E-mail: [info@bender-service.com](mailto:info@bender-service.com)**



# INDEX

## A

- Address assignment 10
- Application with internal BMS bus 15

## B

- BMS bus 14
- BMS device address assignment on the  
Modbus 30
- Byte offset 43
- Byte or word swapping 43

## C

- COM460IP on the internal BMS bus 15
- Commissioning 19

## D

- Damage in transit 63
- Determining address data 22
- Dimension diagram 61
- Display and operating elements 23

## E

- Exception code 25

## F

- Factory setting 20

## I

- Intended use 9

## M

- Malfunctions 63
- Measured value descriptions for the process  
image, list 45
- Memory image of a BMS device 32
- Memory scheme of the process image 30
- Modbus
  - Address structure for BMS devices  
27
  - Control commands 57
  - Function code 29
  - Process image 29
  - Requests 26
  - Responses 26

## O

- Ordering data 62
- Overview of chapters 7

## P

- Process image 30
- Product description 11

## Q

- Quick reference guide 8

## R

- Reference data records of the process image  
41

## **S**

Scope of supply 11

Settings 19

Support 64

## **T**

Technical data 59

Termination 10

Termination of the BMS bus 18

Troubleshooting 63

## **U**

UL applications, restrictions 17

Using this manual 7

## **W**

Wiring diagram 17

Work activities on electrical installations 9



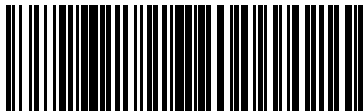

D0001100MXXEN



**Bender GmbH & Co. KG**

Londorfer Str. 65 • 35305 Grünberg • Germany

Postfach 1161 • 35301 Grünberg • Germany

Tel.: +49 6401 807-0

Fax: +49 6401 807-259

E-Mail: [info@bender-de.com](mailto:info@bender-de.com)

Web: <http://www.bender-de.com>

**BENDER Group**

---