

ISOMETER® IR155-4203/IR155-4204

Insulation monitoring device (IMD) for unearthed DC drive systems (IT systems) in electric vehicles

Version V004

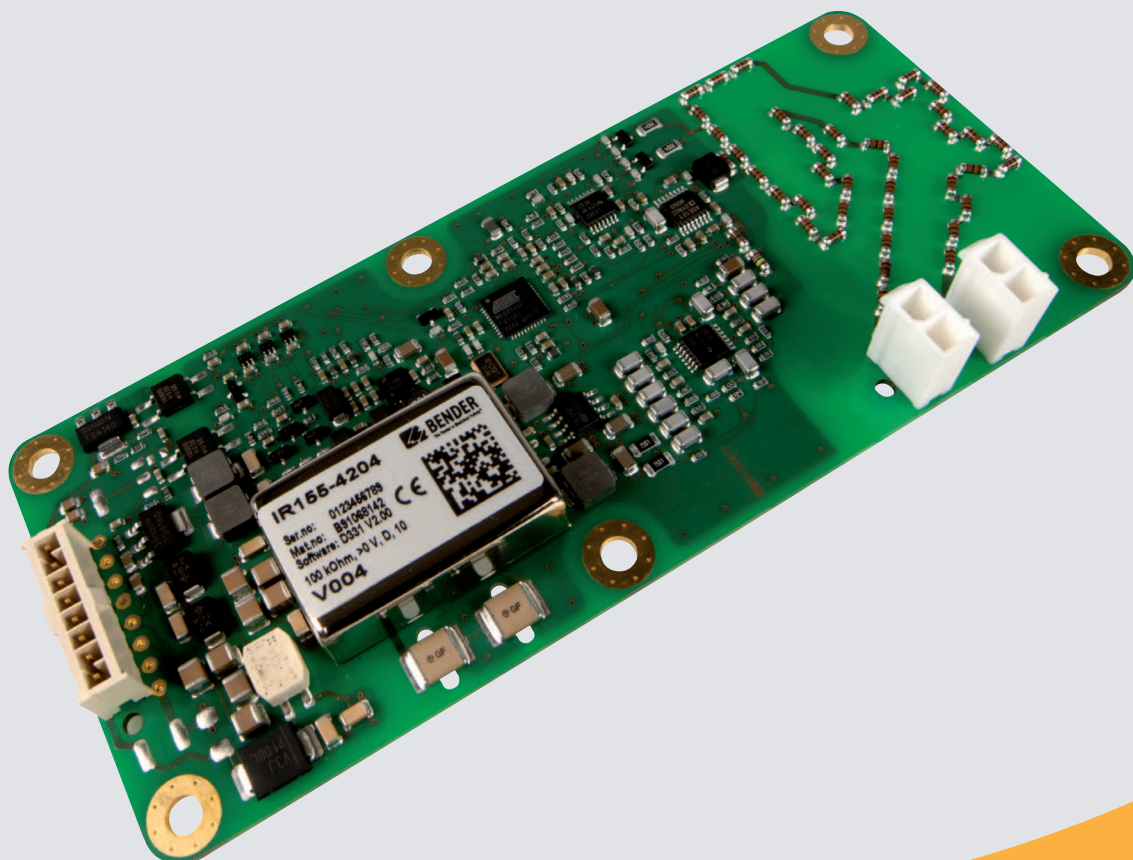

ISOMETER® IR155-4203/IR155-4204

Insulation monitoring device (IMD) for unearthed DC drive systems (IT systems) in electric vehicles

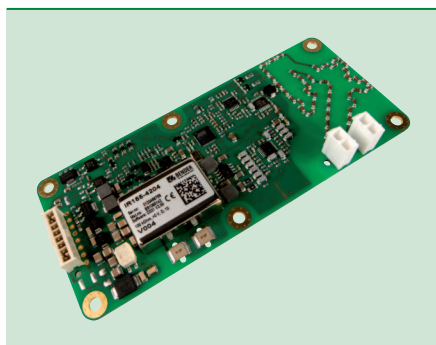

ISOMETER® IR155-4204

Device features

- Suitable for 12 V and 24 V systems
- Automatic device self test
- Continuous measurement of insulation resistance 0...10 MΩ
 - Response time < 2 s after power on for first estimated insulation resistance (SST)
 - Response time < 20 s for measured insulation resistance (DCP)
- Automatic adaptation to the existing system leakage capacitance ($\leq 1 \mu\text{F}$)
- Detection of ground faults and lost ground line
- Isolation monitoring of AC and DC insulation faults for unearthed systems (IT systems) 0 V...1000 V peak
- Low voltage detection for voltages below 500 V (value configurable EOL Bender)
- Short protected outputs for:
 - Fault detection (high side output)
 - Measurement value (PWM 5 % ... 95 % & status (f = 10 Hz...50 Hz) at high or inverted low side driver (M_{HS}/M_{LS} output)
- Conformal coating (SL1301ECO-FLZ)

ATTENTION



Observe precautions for handling electrostatic sensitive devices.
Handle only at safe work stations.

ATTENTION



The device is monitoring HIGH VOLTAGE.
Be aware of HIGH VOLTAGE near to the device.

Product description

The ISOMETER® iso-F1 IR155-4203/-4204 monitors the insulation resistance between the insulated and active HV-conductors of an electrical drive system ($U_n = \text{DC } 0 \text{ V} \dots 1000 \text{ V}$) and the reference earth (chassis ground ▶ Kl.31). The patented measurement technology is used to monitor the condition of the insulation on the DC side as well as on the AC motor side of the electrical drive system. Existing insulation faults will be signalled reliably even under high system interferences which can be caused by motor control processes, accelerating, energy recovering etc.

Due to its space saving design and optimised measurement technology, the device is optimised for use in hybrid or fully electric vehicles. The device meets the increased automotive requirements with regard to the environmental conditions (e.g. temperatures and vibration, EMC...).

The fault messages (insulation fault at the HV-system, connection or device error of the IMD) will be provided at the integrated and galvanic isolated interface (high- resp. low-side driver). The interface consists of a status output (OK_{HS} output) and a measurement output (M_{HS}/M_{LS} output). The status output signals errors resp. the "good" condition. The measurement output signals the actual insulation resistance. Furthermore it's possible to distinguish between different fault messages and device conditions, which are base frequency encoded.

Function

The ISOMETER® iso-F1 IR155-4203/-4204 generates a pulsed measuring voltage, which is superimposed on the IT system by the terminals L+/L- and E/KE. The currently measured insulation condition is available as a pulse-width-modulated signal at the terminals M_{HS} resp. M_{LS} . The connection between the terminals E/KE and the chassis ground (▶ Kl.31) is continuously monitored. Therefore it's necessary to install two separated conductors from the terminals E resp. KE to chassis ground.

Once power is switched on, the device performs an initialisation and starts the SST measurement. The device provides the first estimated insulation resistance during a maximum time of 2 sec. The DCP measurement (▶ continuous measurement method) starts subsequently. Faults in the connecting wires or functional faults will be automatically recognised and signalled.

During operation, a self test is carried out automatically every five minutes. The interfaces will not be influenced by these self tests.

Standards

Corresponding norms and regulations*

IEC 61557-8	2007-01
IEC 61010-1	2010-06
IEC 60664-1	2004-04
ISO 6469-3	2001-11
ISO 23273-3	2006-11
ISO 16750-1	2006-08
ISO 16750-2	2010-03
ISO 16750-4	2010-04
e1 acc. 72/245/EWG/EEC	2009/19/EG/EC
DIN EN 60068-2-38	Z/AD:2010
DIN EN 60068-2-30	Db:2006
DIN EN 60068-2-14	Nb:2010
DIN EN 60068-2-64	Fh:2009
DIN EN 60068-2-27	Ea:2010

* Normative exclusion

The device went through an automotive test procedure in combination of multi customer requirements reg. ISO16750-x.
The norm IEC61557-8 will be fulfilled by creating the function for LED warning and test button at the customer site if necessary.
The device includes no surge and load dump protection above 60 V. An additional central protection is necessary.

Abbreviations

DCP	Direct Current Pulse
SST	Speed Start Measuring

Wiring diagrams

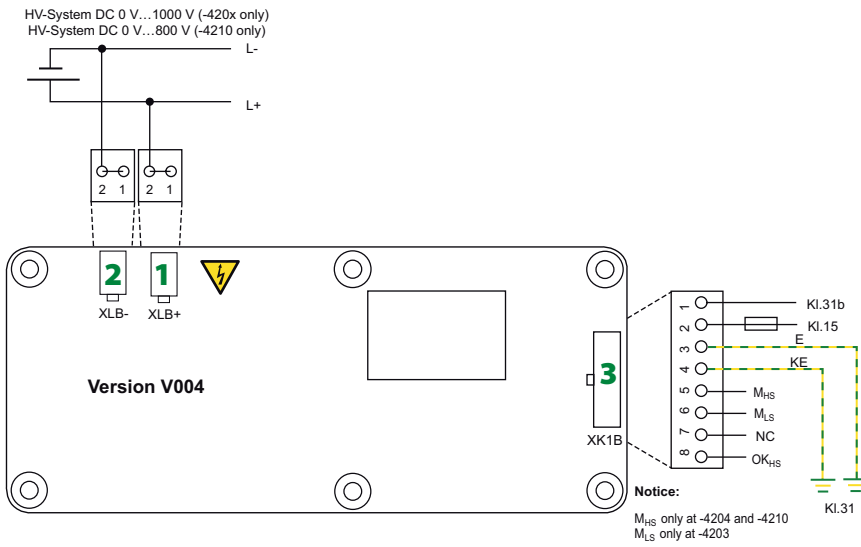

1 - Connector XLB+

Pin 1+2 L+ Line voltage

2 - Connector XLB-

Pin 1+2 L- Line voltage

3 - Connector XK1B

Pin 1 Kl. 31 Chassis ground

Pin 2 Kl. 15 Supply voltage

Pin 3 Kl. 31 Chassis ground

Pin 4 Kl. 31 Chassis ground (sep. line)

Pin 5 M_{HS} Data Out, PWM (high side)

Pin 6 M_{LS} Data Out, PWM (low side)

Pin 7 n.c.

Pin 8 OK_{HS} Status Output (high side)

Typical application

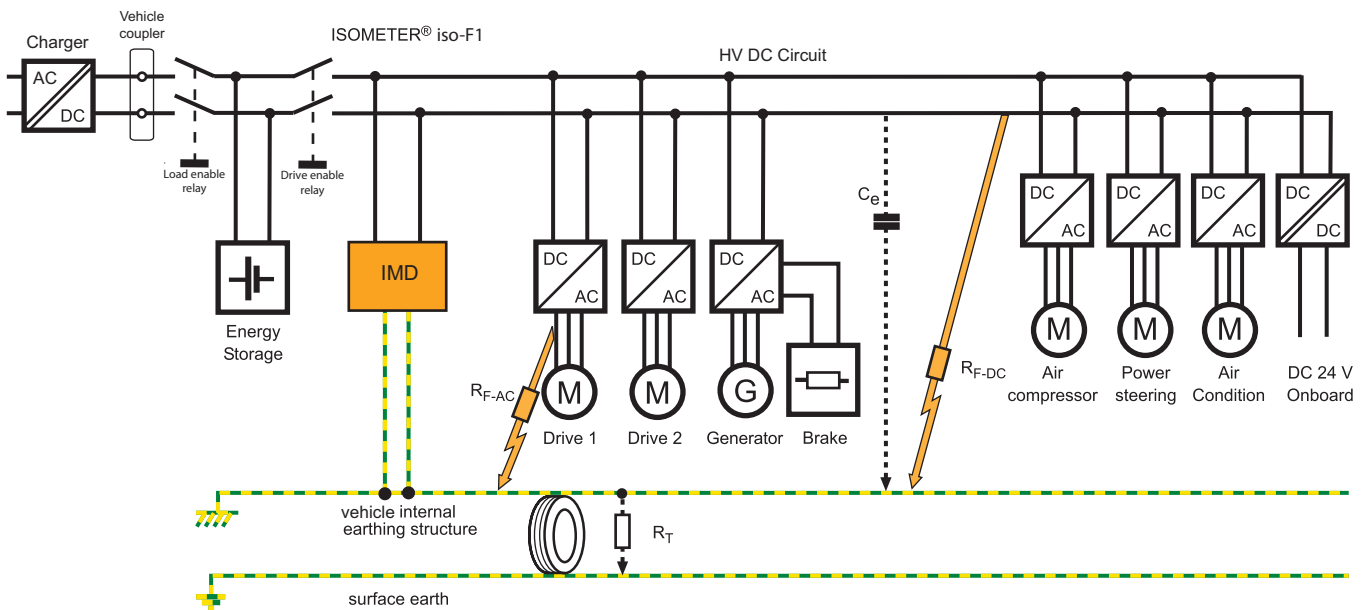

Technical data

Insulation coordination acc. to IEC 60664-1

Protective separation (reinforced insulation)
between (L+/L-) – (Kl. 31, Kl. 15, E, KE, M_{HS} , M_{LS} , OK_{HS})

Voltage test AC 3500 V/1 min

Supply/IT system being monitored

Supply voltage U_S	DC 10...36 V
Max. operating current I_S	150 mA
Max. current I_k	2 A
	6 A/2 ms inrush current
HV voltage range (L+/L-) U_n	AC 0...1000 V (peak value) 0...660 V rms (10 Hz...1 kHz) DC 0...1000 V
Power consumption	< 2 W

Response values

Response value hysteresis (DCP)	25 %
Response value R_{an}	100 kΩ...1 MΩ
Undervoltage detection	0...500 V

Measuring range

Measuring range	0...10 MΩ
Undervoltage detection	0...500 V default setting: 0 V (inactive)
Relative uncertainty	
SST (≤ 2 s)	good $> 2^* R_{an}$; bad $< 0.5^* R_{an}$
Relative uncertainty DCP	0...85 kΩ $\triangleright \pm 20$ kΩ
(default setting 100 kΩ)	100 kΩ...10 MΩ $\triangleright \pm 15\%$
Relative uncertainty output M (fundamental frequency)	± 5 % at each frequency (10 Hz; 20 Hz; 30 Hz; 40 Hz; 50 Hz)

Relative uncertainty undervoltage detection $U_n \geq 100$ V $\triangleright \pm 10$ %; at $U_n \geq 300$ V $\triangleright \pm 5$ %

Relative uncertainty (SST) "Good condition" $\geq 2^* R_{an}$
"Bad condition" $\leq 0.5^* R_{an}$

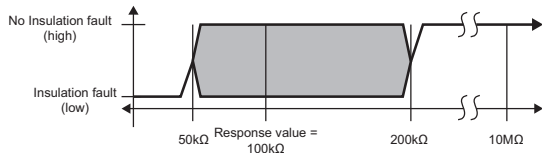

Relative uncertainty DCP	100 kΩ...10 MΩ ± 15 %
	100 kΩ...1.2 MΩ $\triangleright \pm 15$ % to ± 7 %
	1.2 MΩ $\triangleright \pm 7$ %
	1.2...10 MΩ $\triangleright \pm 7$ % to ± 15 %
	10 MΩ $\triangleright \pm 15$ %

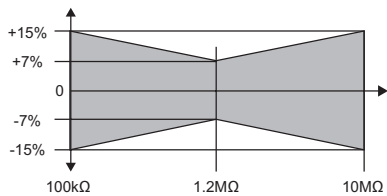

Absolute uncertainty 0...85 kΩ $\triangleright \pm 20$ kΩ

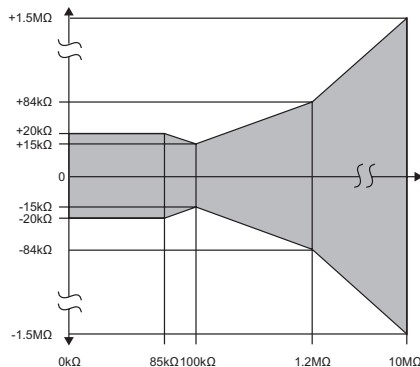

Time response

Response time t_{an} (OK_{HS} ; SST) $t_{an} \leq 2$ s (typ. < 1 s at $U_n > 100$ V)
Response time t_{an} (OK_{HS} ; DCP)

(when changing over from $R_F = 10$ MΩ to $R_{an}/2$; at $C_e = 1$ μF; $U_n = DC$ 1000 V)
 $t_{an} \leq 20$ s (at $F_{ave} = 10^*$)
 $t_{an} \leq 17.5$ s (at $F_{ave} = 9$)
 $t_{an} \leq 17.5$ s (at $F_{ave} = 8$)
 $t_{an} \leq 15$ s (at $F_{ave} = 7$)
 $t_{an} \leq 12.5$ s (at $F_{ave} = 6$)
 $t_{an} \leq 12.5$ s (at $F_{ave} = 5$)
 $t_{an} \leq 10$ s (at $F_{ave} = 4$)
 $t_{an} \leq 7.5$ s (at $F_{ave} = 3$)
 $t_{an} \leq 7.5$ s (at $F_{ave} = 2$)
 $t_{an} \leq 5$ s (at $F_{ave} = 1$)
 during the self test $t_{an} + 10$ s

Switch-off time t_{ab} (OK_{HS} ; DCP)

(when changing over from $R_F = 10$ MΩ to $R_{an}/2$; at $C_e = 1$ μF; $U_n = DC$ 1000 V)
 $t_{ab} \leq 40$ s (at $F_{ave} = 10$)
 $t_{ab} \leq 40$ s (bei $F_{ave} = 9$)
 $t_{ab} \leq 33$ s (at $F_{ave} = 8$)
 $t_{ab} \leq 33$ s (at $F_{ave} = 7$)
 $t_{ab} \leq 33$ s (at $F_{ave} = 6$)
 $t_{ab} \leq 26$ s (at $F_{ave} = 5$)
 $t_{ab} \leq 26$ s (at $F_{ave} = 4$)
 $t_{ab} \leq 26$ s (at $F_{ave} = 3$)
 $t_{ab} \leq 20$ s (at $F_{ave} = 2$)
 $t_{ab} \leq 20$ s (at $F_{ave} = 1$)
 during a self test $t_{ab} + 10$ s

Duration of the self test 10 s
(every five minutes; should be added to t_{an}/t_{ab})

Measuring circuit

System leakage capacitance $C_e \leq 1$ μF
 Smaller measurement range and increased measuring time at $C_e > 1$ μF
 (e.g. max. range 1 MΩ @ 3 μF,
 $t_{an} = 68$ s when changing over from R_F 1 MΩ to $R_{an}/2$)

Measuring voltage U_M	± 40 V
Measuring current I_M at $R_F = 0$	± 33 μA
Impedance Z_i at 50 Hz	≥ 1.2 MΩ
Internal DC resistance R_i	≥ 1.2 MΩ

* $F_{ave} = 10$ is recommended for electric and hybrid vehicles

Output

Measurement output (M)

M_{HS} switches to $U_S - 2V$ (3204)
(external pull-down resistor to Kl. 31 necessary 2.2 kΩ)
 M_{LS} switches to Kl. 31 + 2V (3203)
(external pull-up resistor to Kl. 15 required 2.2 kΩ)

0 Hz ▶ Hi > short-circuit to $U_b + (Kl. 15)$; Low > IMD off or short-circuit to Kl. 31
10 Hz ▶ Normal condition
Insulation measurement DCP;
starts two seconds after power on;
First successful insulation measurement at ≤ 17.5 s
PWM active 5...95 %

20 Hz ▶ undervoltage condition
Insulation measurement DCP (continuous measurement);
starts two seconds after power on;
PWM active 5...95 %
First successful insulation measurement at ≤ 17.5 s
Undervoltage detection 0...500 V
(Bender configurable)

30 Hz ▶ Speed start measurement
Insulation measurement (only good/bad evaluation)
starts directly after power on ≤ 2 s;
PWM 5...10 % (good) and 90...95 % (bad)

40 Hz ▶ Device error
Device error detected; PWM 47.5...52.5 %

50 Hz ▶ Connection fault earth
Fault detected on the grounding connection (Kl. 31)
PWM 47.5...52.5 %

Status output (OK_{HS})

OK_{HS} switches to $U_S - 2V$
(external pull-down resistor to Kl. 31 required 2.2 kΩ)

High ▶ No fault; $R_F >$ response value
Low ▶ Insulation resistance \leq response value detected;
Device error; Fault in the grounding connection
Undervoltage detected or device switched off

Operating principle PWM driver

- Condition "Normal" and "Undervoltage detected" (10 Hz; 20 Hz)
Duty cycle 5 % = > 50 MΩ (∞)
Duty cycle 50 % = 1200 kΩ
Duty cycle 95 % = 0 kΩ

$$R_F = \frac{90\% \times 1200\text{ k}\Omega}{dc_{meas} - 5\%} - 1200\text{ k}\Omega$$

dc_{meas} = measured duty cycle (5 %...95 %)



Operating principle PWM driver

- Condition "SST" (30 Hz)

Duty cycle ▶ 5...10 % ("good")
90...95 % ("bad")

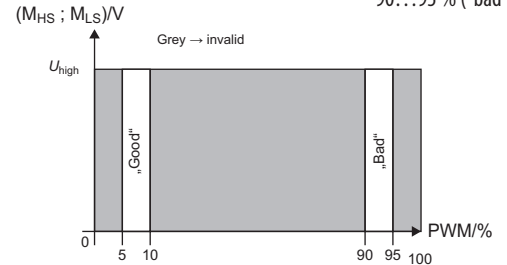

Operating principle PWM driver

- Condition "Device error" and "Kl.31 fault" (40 Hz; 50 Hz);

Duty cycle ▶ 47.5...52.5 %

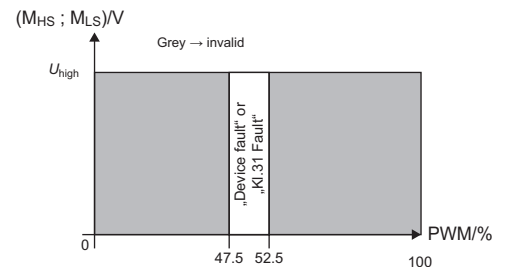

Load current I_L	80 mA
Turn-on time ▶ to 90 % V_{out}	max. 125 μ s
Turn-on time ▶ to 10 % V_{out}	max. 175 μ s
Slew rate on ▶ 10...30 % V_{out}	max. 6 V/ μ s
Slew rate off ▶ 70...40 % V_{out}	max. 8 V/ μ s
Timing 3204 (inverse to 3203)	

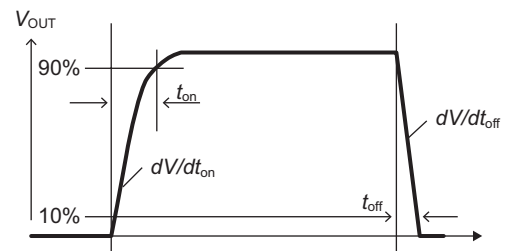

EMC

Load dump protection	< 60 V
Measurement method	Bender-DCP technology
Factor averaging	
F_{ave} (output M)	1...10 (factory set: 10)

ESD protection

Contact discharge – directly to terminals	≤ 10 kV
Contact discharge – indirectly to environment	≤ 25 kV
Air discharge – handling of the PCB	≤ 6 kV

Connection

Connectors	Samtec Mini Mate Housing, IPD1-08-S-K (Kl. 31B, Kl.15, KE, E, M_{HS} , M_{LS} , OK_{HS}) Molex Mini Fit Jr. Housing, 39-01-2025, (L+, L-)
Crimp contacts	Samtec Mini Mate Gold, CC79R2024-01-L, AWG 20...24 Molex Mini Fit Jr. Gold, 39-00-0089, AWG 16

General data

Necessary crimp tongs (TYCO)	91501-1
Operating mode/mounting	continuous operation/any position
Temperature range	-40...+105°C
Voltage failure	≤ 2 ms
Flammability class acc. to	UL94 V-0

Mounting

M4 metal screws with locking washers between screw head and PCB. Torx, T20 with a maximum tightening torque of 4 Nm for the screws. Furthermore maximum 10 Nm pressure to the PCB at the mounting points.

Mounting and connector kits are not included in delivery, but are available as accessories. The maximum diameter of the mounting points is 10 mm.

Before mounting the device, ensure sufficient insulation between the device and the vehicle resp. the mounting points (min. 11,4 mm to other parts). If the device is mounted on a metal or conductive subsurface, this subsurface has to get ground potential (KI.31; vehicle mass).	
Deflection	max. 1% of the length resp. width of the PCB
Coating	thick-film-lacquer
Weight	52 g ± 2 g

Dimension diagram

Dimensions in mm

PCB dimensions (L x W x H) 140 mm x 60 mm x 15 mm

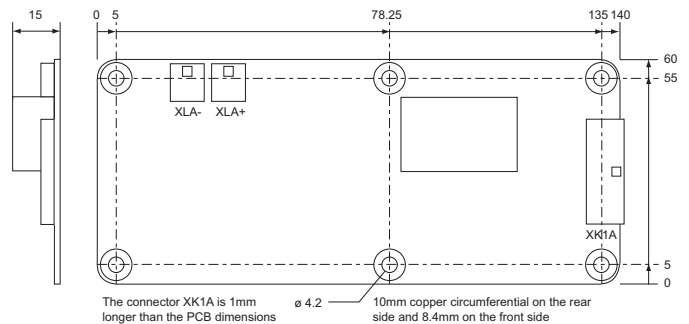

Ordering information

Parameters	Response value R_{an}	F_{ave}	Undervoltage detection	Measured value output	Type	Art. No.
Continuously set value	100 kΩ	10	300 V	Low-side	IR155-4203	B 9106 8141
			0 V (inactive)	High-side	IR155-4204	B 9106 8142
Customer-specific setting	100 kΩ...1 MΩ	1...10	0 V...500 V	Low-side	IR155-4203	B 9106 8141C
				High-side	IR155-4204	B 9106 8142C

Accessories

Type designation	Art. No.
Fastening set	B 9106 8500
Connector set IR155-42xx	B 9106 8502

Example for ordering

IR155-4204-100kΩ-0V + B 9106 8142

IR155-4204-200kΩ-100V + B 9106 8142C

The parameters acc. response value and under voltage protection have always to be added or included to an order.



Bender GmbH & Co. KG

P.O. Box 1161 • 35301 Gruenberg • Germany
 Londorfer Strasse 65 • 35305 Gruenberg • Germany
 Tel.: +49 6401 807-0 • Fax: +49 6401 807-259
 E-Mail: info@bender.de • www.bender-emobility.com



BENDER Group