

LINETRAXX® VME421H

Multi-functional monitoring relay for undervoltage, overvoltage and frequency monitoring in AC/DC systems without separate supply voltage



LINETRAXX® VME421H

Multi-functional relay for undervoltage, overvoltage and frequency monitoring in AC/DC systems without external supply voltage



LINETRAXX® VME421H

Device features

- Monitoring undervoltage, overvoltage and frequency of AC/DC systems of 9.6...150 V (VME421H-D-1), 70...300 V (VME421H-D-2)
- Without external supply voltage
- Integrated energy backup
- Various monitoring functions selectable $< U, > U, < f, > f$
- Start-up delay, response delay, delay on release
- Adjustable switching hysteresis
- r.m.s. value measurement (AC+DC)
- Digital measured value display via multi-functional LC display
- Preset function (automatic setting of basic parameters)
- LEDs: Power On, Alarm 1, Alarm 2
- Measured value memory for operating value
- Continuous self monitoring
- Internal test/reset button
- Two separate alarm relays (one changeover contact each)
- N/C or N/O operation and fault memory behaviour selectable
- Password protection for device setting
- Sealable transparent cover
- Two-module enclosure (36 mm)
- Push-wire terminal (two terminals per connection)
- RoHS compliant

Approvals



Product description

The VME421H series voltage relays are designed to monitor the frequency, undervoltage, overvoltage and the voltage between two threshold values (window discriminator function) in AC and DC systems. The voltages are measured as r.m.s. values. The currently measured value is continuously shown on the LC display. The measured value required to trigger the alarm relay is stored. Due to adjustable response times, installation-specific characteristics, such as device-specific start-up procedures, short-time voltage fluctuations, etc. can be considered. The device is supplied with power by the system being monitored and utilises an internal energy backup.

Typical applications

- Voltage and frequency monitoring of single-phase machines and electrical installations
- Earth fault monitoring in medium-voltage systems via voltage transformers
- Monitoring of battery systems
- Switching machinery and equipment on and off at a certain voltage level

Function

Once the supply voltage is applied, the start-up delay "t" begins. Measured voltage and frequency values changing during this time do not influence the switching state of the alarm relays.

The devices feature two separately adjustable measuring channels (overvoltage/undervoltage). When the measuring quantity exceeds the response value ("Alarm 1") or falls below the response value ("Alarm 2"), the time of the response delays "t_{on1/2}" begins. Once the response delay has elapsed, the alarm relays switch and the alarm LEDs light up. When the measuring value exceeds or falls below the release value (response value plus hysteresis) after the alarm relays have switched, the selected release delay "t_{off}" begins. When "t_{off}" has elapsed, the alarm relays switch back to their initial position. When the fault memory is activated, the alarm relays remain in alarm position until the reset button R is pressed.

Energy backup

Also in the event of complete power failure of the system being monitored, the delay times are effective during the energy backup time. When the fault memory is set to continuous mode, the alarm parameters remain stored, even on failure of the supply voltage.

Preset function

After connecting the device for the first time, the nominal system voltage will be determined (PrE run), and the response values for overvoltage and undervoltage as well as for underfrequency and overfrequency will automatically be set. When no voltage is determined within a nominal system voltage range (PrE run), the response values will be set to the minimum or maximum voltage. In this case, the message "AL not SET" appears on the display. As long as no button is pressed, a nominal system voltage is being searched cyclically (PrE run). If a button is pressed, the search will be interrupted and the message "AL not SET" disappears. In this case, the appropriate response values have to be set in the menu. When activating the frequency monitoring function, the preset frequency will automatically be stored.



Operating elements

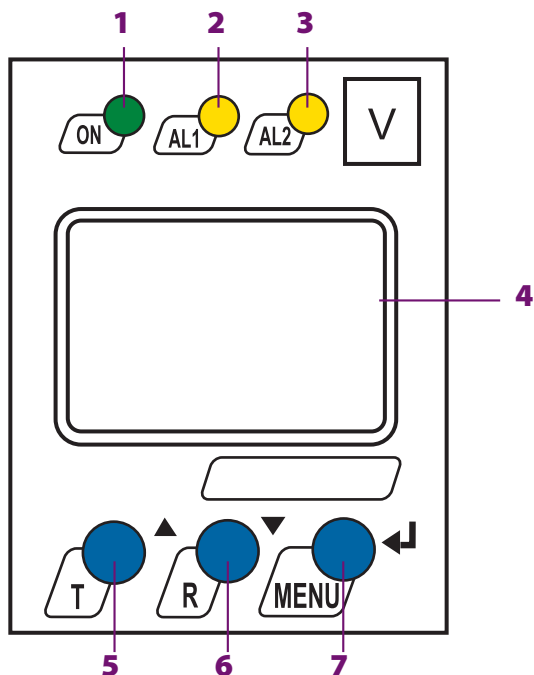

- 1 - Power On LED "ON" (green); lights when supply voltage is applied and flashes in the event of system fault alarm
- 2 - Alarm LED "AL1" (yellow), lights when the set response value $>U/<f>f$ is exceeded and flashes in the event of system fault alarm
- 3 - Alarm LED "AL2" (yellow), lights when the value falls below the set response value $<U/<f>f$ and flashes in the event of system fault alarm
- 4 - Multi-functional LC display
- 5 - Test button "T":
Arrow up button: To change the measured value display, move upwards in the menu or to change parameters.
To call up the self test: press the button "T" >1.5 s
- 6 - Reset button "R":
Arrow down button: to change the measured value indication, move downwards in the menu or to change parameters
To delete stored alarms: press the button "T" >1.5 s
- 7 - "MENU" button:
Enter button: to confirm the measured value indication or to confirm changed parameters
To call up the menu system, press the button "T" >1.5 s
Press the ESC button >1.5 s to abort an action or to return to the previous menu level

Wiring diagram

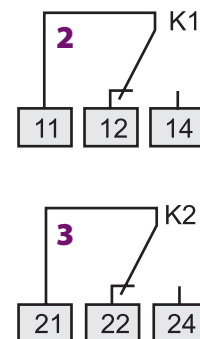
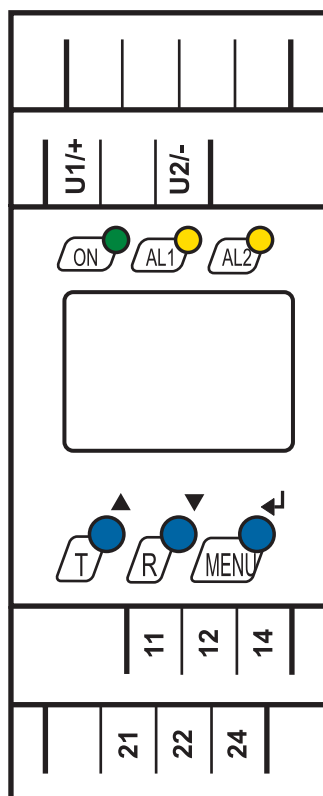
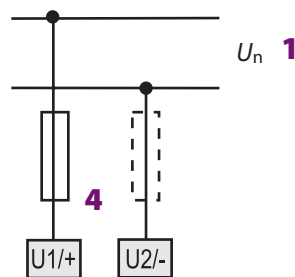

- 1 - Connection to the system/load being monitored
- 2 - Alarm relay "K1": Configurable for $<U/>U/<f/>f/ERROR$
- 3 - Alarm relay "K2": Configurable for $<U/>U/<f/>f/ERROR$
- 4 - Line protection according to IEC 60364-4-43:
A fuse recommended recommended. If being supplied from an IT system, both lines have to be protected by a fuse.

Timing diagram voltage monitoring

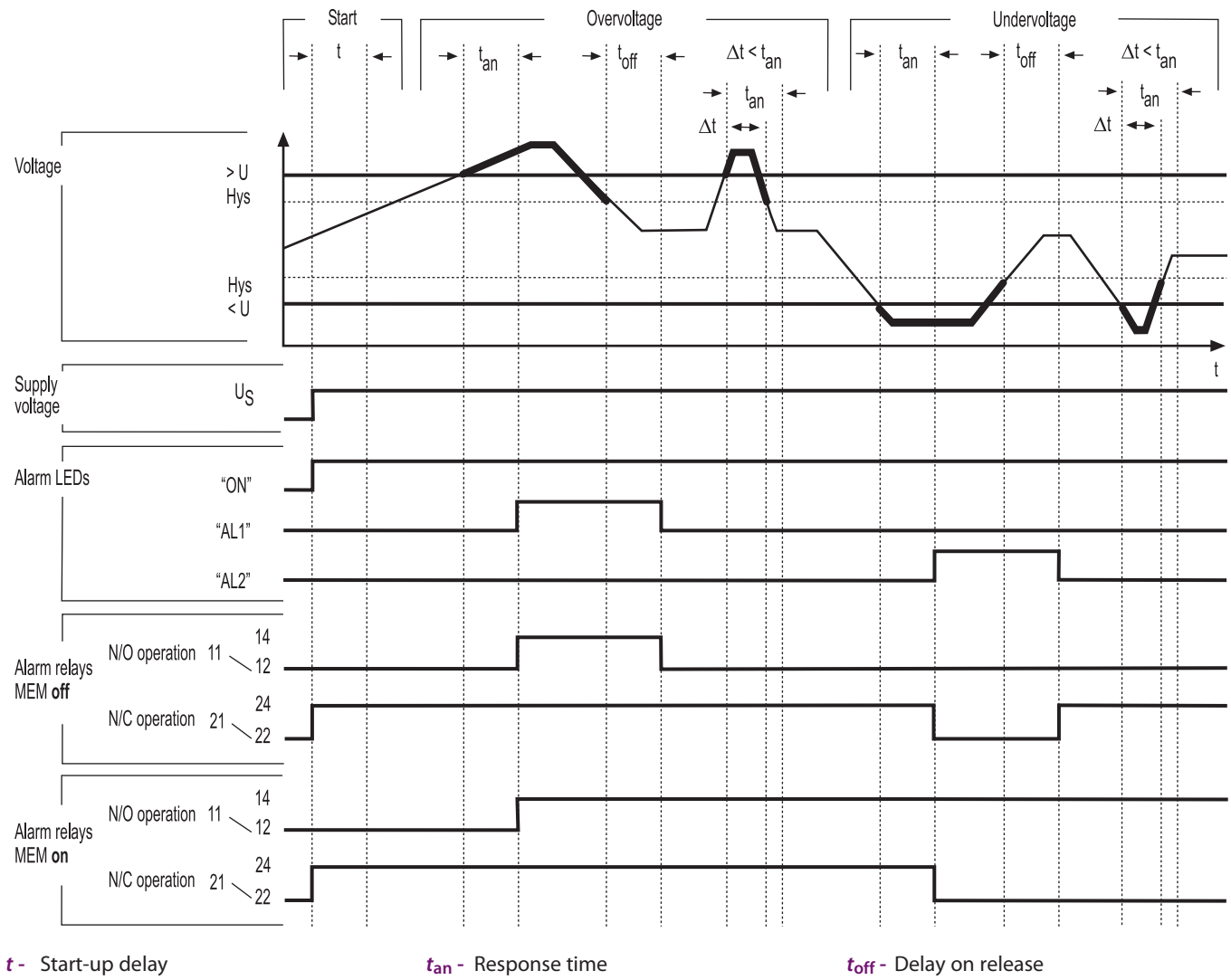

Technical data
Insulation coordination acc. to IEC 60664-1/IEC 60664-3

Rated insulation voltage	250 V
Rated impulse voltage/pollution degree	4 kV/3
Overtoltage category	III
Protective separation (reinforced insulation) between:	(U1/+, U2/-) - (11-12-14) - (21-22-24)
Voltage test acc. to IEC 61010-1	2.21 kV

Supply voltage

VME421H-D-1:	
Supply voltage U_s	none (internally supplied by U_n)

VME421H-D-2:	
Supply voltage U_s	none (internally supplied by U_n)
Power consumption	≤ 6 VA

Measuring circuit

Measuring range (r.m.s. value) (VME421H-D-1)	AC/DC 0...150 V
Measuring range (r.m.s. value) (VME421H-D-2)	AC/DC 0...300 V
Rated frequency f_n	DC, 15...460 Hz
Frequency display range	10...500 Hz

Response values

VME421H-D-1:	
Undervoltage < U (Alarm 2)	AC/DC 9.6...150 V
Overtoltage > U (Alarm 1)	AC/DC 9.6...150 V

Preset function:	
Undervoltage < U (0.85 U_n)* for $U_n = 120/60/24$ V	102/51/20.4 V
Overtoltage > U (1.1 U_n)* for $U_n = 120/60/24$ V	132/66/26.4 V
Resolution of setting U 9.6...49.9 V	0.1 V
Resolution of setting U 50...150 V	1 V

VME421H-D-2:	
Undervoltage < U (ALARM 2)	AC/DC 70...300 V
Overtoltage > U (ALARM 1)	AC/DC 70...300 V
Resolution of setting U 70...300 V	1 V

Preset function:	
Undervoltage < U (0.85 U_n)* for $U_n = 230/120$ V	196/102 V
Overtoltage > U (1.1 U_n)* for $U_n = 230/120$ V	253/132 V

VME421H...:	
Relative uncertainty voltage at 50/60 Hz	1.5 %, 2 digits
Relative uncertainty voltage in the range 15...460 Hz	± 3 %, ± 2 digit
Hysteresis U	1...40 % (5 %)*
Underfrequency < Hz	10...500 Hz**
Overfrequency > Hz	10...500 Hz**
Resolution of setting f 10.0...99.9 Hz	0.1 Hz
Resolution of setting f 100...500 Hz	1 Hz
Preset function:	
Underfrequency for $f_n = 400/60/50/16.7$ Hz	399/59/49/15.7 Hz
Overfrequency for $f_n = 400/60/50/16.7$ Hz	401/61/51/17.7 Hz
Hysteresis frequency Hys Hz	0.1...2 Hz (0.2 Hz)*
Relative uncertainty, frequency in the range of 15...460 Hz	± 0.2 %, ± 1 digit

Time response

Start-up delay t	0...300 s (0 s)*
Response delay $t_{on1/2}$	0...300 s (0 s)*
Delay on release t_{off}	0...300 s (0.5 s)*
Resolution of setting $t, t_{on1/2}, t_{off}$ (0...10 s)	0.1 s
Resolution of setting $t, t_{on1/2}, t_{off}$ (10...99 s)	1 s
Resolution of setting $t, t_{on1/2}, t_{off}$ (100...300 s)	10 s
Operating time, voltage t_{ae}	DC/AC 16.7 Hz: ≤ 130 ms, AC 42...460 Hz: ≤ 70 ms
Operating time frequency t_{ae}	AC 15...460 Hz: ≤ 310 ms
Response time t_{an}	$t_{an} = t_{ae} + t_{on1/2}$
Discharging time energy backup on power failure (VME421H-D-1)	3 s
Discharging time energy backup on power failure (VME421H-D-1)	2.5 s at $f_n < 42$ Hz
Discharging time energy backup (VME421H-D-2)	≥ 4 s at DC 70 V
	≥ 6 s at DC 80 V/AC 70 V
Charging time energy backup (VME421H-D-1)	60 s
Charging time energy backup (VME421H-D-2)	120 s
Recovery time t_b	≤ 300 ms

Displays, memory

Display	LC display, multifunctional, not illuminated
Display range measured value (VME421H-D-1)	AC/DC 0...150 V
Display range measured value (VME421H-D-2)	AC/DC 0...300 V
Operating uncertainty at 50/60 Hz	± 1.5 %, ± 2 digits
Operating uncertainty voltage in the range of 15...460 Hz	± 3 %, ± 2 digits
Operating uncertainty in the frequency range 15...460 Hz	± 0.2 %, ± 1 digit
History memory (HiS) for the first alarm value	data record measured values
Password	off/0...999 (off)*
Fault memory (M) alarm relay	on/off/con (on)*

Switching elements

Number	2 x 1 changeover contacts (K1, K2)
Operating principle	N/C operation/N/O operation
	K2: Err, < U , > U , < Hz, > Hz, S.AL (undervoltage < U : N/C operation n.c.)*
	K1: Err, < U , > U , < Hz, > Hz, S.AL (overtoltage > U : N/O operation n.o.)*

Electrical endurance, number of cycles	10000
Contact data acc. to IEC 60947-5-1:	

Utilisation category	AC 13	AC 14	DC-12	DC-12	DC-12
Rated operational voltage	230 V	230 V	24 V	110 V	220 V
Rated operational current	5 A	3 A	1 A	0.2 A	0.1 A
Minimum contact rating	1 mA at AC/DC ≥ 10 V				

Environment/EMC

EMC	IEC 61326-1
Operating temperature	-25...+55 °C
Classification of climatic conditions acc. to IEC 60721:	
Stationary use (IEC 60721-3-3)	3K5 (except condensation and formation of ice)
Transport (IEC 60721-3-2)	2K3 (except condensation and formation of ice)
Long-time storage (IEC 60721-3-1)	1K4 (except condensation and formation of ice)
Classification of mechanical conditions acc. to IEC 60721:	
Stationary use (IEC 60721-3-3)	3M4
Transport (IEC 60721-3-2)	2M2
Storage (IEC 60721-3-1)	1M3

Connection

Connection type	push-wire terminals
Connection properties	
rigid	0.2...2.5 mm ² (AWG 24...14)
flexible without ferrule	0.2...2.5 mm ² (AWG 24...14)
flexible with ferrule	0.2...1.5 mm ² (AWG 24...16)
Stripping length	10 mm
Opening force	50 N
Test opening, diameter	2.1 mm

Other

Operating mode	continuous operation
Mounting	any position
Degree of protection, internal components (DIN EN 60529)	IP30
Degree of protection, terminals (DIN EN 60529)	IP20
Enclosure material	polycarbonate
Screw mounting	2 x M4 with mounting clip
DIN rail mounting acc. to	IEC 60715
Flammability class	UL94 V-0
Documentation number	D00141
Weight	≤ 240 g

()* = factory setting

** = The technical data applies to the operating range of the rated frequency 15...460 Hz only.

Ordering information

Nominal system voltage ¹⁾ U _n		Type	Art. No.
DC	AC		
9.6...150 V	9.6...150 V, 15...460 Hz	VME421H-D-1	B 7301 0003
70...300 V	70...300 V, 15...460 Hz	VME421H-D-2	B 7301 0004

Device version with screw terminals on request.

¹⁾ Absolut values

Accessories

Type designation	Art. No.
Mounting clip for screw mounting (1 piece per device)	B 9806 0008

Dimension diagram XM421

Dimensions in mm

Open the front plate cover in direction of arrow!

Screw mounting

Note: The upper mounting clip must be ordered separately (see ordering information).

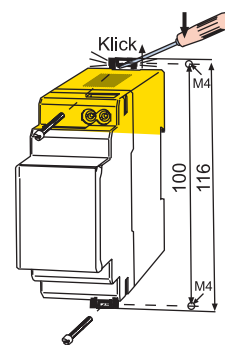
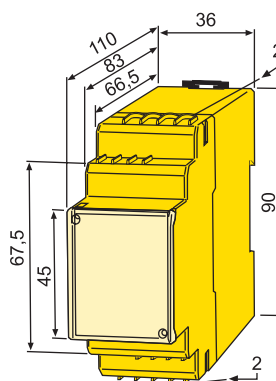

Bender GmbH & Co. KG

P.O. Box 1161 • 35301 Gruenberg • Germany
 Londorfer Strasse 65 • 35305 Gruenberg • Germany
 Tel.: +49 6401 807-0 • Fax: +49 6401 807-259
 E-Mail: info@bender.de • www.bender.de



BENDER Group