

**Measuring current transformers of the
W... series**

**Measuring current transformers of the
W...-8000 series**



Measuring current transformers of the W... series

Measuring current transformers of the W...-8000 series



W60 – W60-8000 measuring current transformers



W20 – W20-8000 mounted on DIN rail

Device features

W... measuring current transformers

- For RCMS460/490 series residual current monitoring systems
- For RCM420, RCM460 and RCM470 series residual current monitors
- For EDS470, EDS460 / 490 series insulation fault locators

W...-8000 measuring current transformers

- for EDS473(E)-12, EDS474(E)-12, EDS461 and EDS491 series insulation fault locators

Standards, approvals and certifications



Product description

The highly sensitive W... and W...-8000 series measuring current transformers convert AC currents into evaluable measurement signals, in combination with RCM resp. RCMS series residual current monitors and evaluators.

In addition, the measuring current transformers can be used in combination with insulation fault location systems (EDS) for IT systems. They are designed to measure the locating current generated by a PGH locating current injector or an A-ISOMETER® IRDH. In combination with EDS series insulation fault locators the test current is converted into evaluable signals. Connection to the respective devices is via a two-wire cable.

Standards

WS... and WS...-8000 series measuring current transformers comply with the device standard: IEC 60044-1.

Installation instructions

- Make sure that all live conductors are routed through the measuring current transformer
- Do not route shielded conductors through the measuring current transformer
- Never route a PE conductor through the measuring current transformer!

Wiring diagram

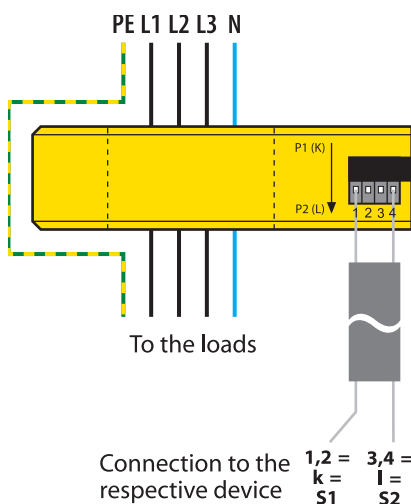

W... measuring current transformers

Connection to the respective RCMS series residual current monitoring system, RCM series residual current monitor or to an EDS series insulation fault location system.

W...-8000 measuring current transformers

Connection to the respective EDS473(E)-12, EDS474(E)-12, EDS461 and/or EDS491 series insulation fault locator.

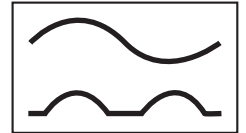

Technical data

Insulation coordination acc. to IEC 60664-1

Rated insulation voltage	800 V
Rated impulse voltage/pollution degree	8 kV / III

CT circuit W...

Rated primary residual current	10 mA...10 A
Rated secondary residual current	0.0167 A
Rated transformation ratio K_n	10 / 0.0167 A
Rated burden	≤ 180 Ω*
Nominal power	0.05 VA
Frequency range	42 Hz...3 kHz
Rated continuous thermal current I_{cth}	40 A
Rated short-time thermal current I_{tth}	60 x I_{cth} = 2.4 kA / 1 s
Rated dynamic current I_{dyn}	2.5 x I_{tth} = 6.0 kA / 40 ms

CT circuit W...-8000

Rated primary residual current	1 A
Rated secondary residual current	0.125 mA
Rated transformation ratio K_n	1 A / 0.125 mA
Rated burden	2400 Ω
Nominal power	0.0375 VA
Frequency range	42 Hz...3 kHz
Rated continuous thermal current I_{cth}	6 A
Rated short-time thermal current I_{tth}	60 x I_{cth} = 0.36 kA / 1 s
Rated dynamic current I_{dyn}	2.5 x I_{tth} = 0.9 kA / 40 ms

Environment

Operating temperature	-25 °C...+70 °C
Climatic class acc. to IEC 60721	
Stationary use (IEC 60721-3-3)	3K5 (except condensation and formation of ice)
Transport (IEC 60721-3-2)	2K5 (except condensation and formation of ice)
Long-time storage (IEC 60721-3-1)	1K5 (except condensation and formation of ice)
Classification of mechanical conditions IEC 60721	
Stationary use (IEC 60721-3-3)	3M4
Transport (IEC 60721-3-2)	2M2
Long-time storage (IEC 60721-3-1)	1M3

Connection

Connection	cage clamp terminals
rigid/flexible/conductor sizes	0.08...2.5 / 0.08...2.5 mm ² / 28...12 AWG
Stripping length	8...9 mm

Connection EDS, RCM(S) measuring current transformers

Single wire ≥ 0.75 mm ²	0...1 m
Single wire, twisted ≥ 0.75 mm ²	0...10 m
Shielded cable ≥ 0.5 mm ²	0...40 m
Recommended cable	
(shielded, shield on one side connected to I-conductor, not connected to earth)	min. J-Y(St)Y 2x0.8

Other

Degree of protection, internal components (IEC 60529)	IP40
Degree of protection, terminals (IEC 60529)	IP 20
Screw mounting	Oval head screw M5 acc. to DIN 7985 with mounting brackets
Flammability class	UL94 V-0
Operating manual W..., W...-8000	TBP409013
Approvals and certifications	UL under development, GOST

*The rated burden may vary depending on the respective device data sheet.

Ordering information

Type	Internal diameter	Mounting		Art. No.
		DIN rail	Mounting brackets	
W20	20 mm	×	×	B 9808 0003
W35	35 mm	×	×	B 9808 0010
W60	60 mm	×	×	B 9808 0018
W120	120 mm	--	×	B 9808 0028
W210	210 mm	--	×	B 9808 0034
W20-8000*	20 mm	×	×	B 9808 0009
W35-8000*	35 mm	×	×	B 9808 0017
W60-8000*	60 mm	×	×	B 9808 0027

Accessories

Type	Width	Art. No.
Snap-on mounting for W20-W35, W20-W35-8000*	43.5 mm	B 9808 0501
Snap-on mounting for W60, W60-8000*	50 mm	B 9808 0502

Dimension diagram

Dimensions in mm

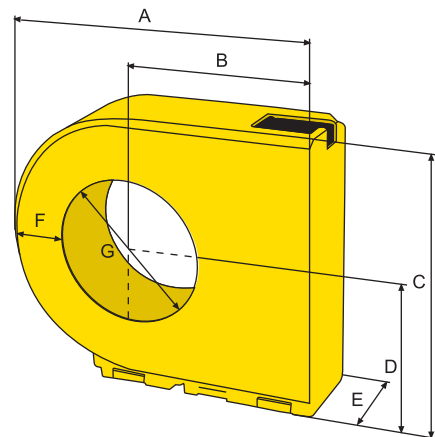

Dimensions

Type	A	B	C	D	E	F	G	Weight
W20	76.4	50	56.3	29.8	30	16.4	∅ 20	≤ 0.13 kg
W35	99.5	62	79.2	41.7	30	20	∅ 35	≤ 0.175 kg
W60	135	79	116.4	60.4	37	24	∅ 60	≤ 0.315 kg
W120	210	116.5	191.5	98	37	33.5	∅ 120	≤ 0.96 kg
W210	323	173	304.5	154.5	45	45	∅ 210	≤ 2.9 kg
W20-8000*	76.4	50	56.3	29.8	30	16.4	∅ 20	≤ 0.15 kg
W35-8000*	99.5	62	79.2	41.7	30	20	∅ 35	≤ 0.205 kg
W60-8000*	135	79	116.4	60.4	37	24	∅ 60	≤ 0.355 kg

Tolerance: ± 0.5 mm

* For EDS461/491 and EDS473/474 series insulation fault locators

Mounting details

Screw mounting with mounting brackets: W20, W35, W60 and W20-8000, W35-8000, W60-8000

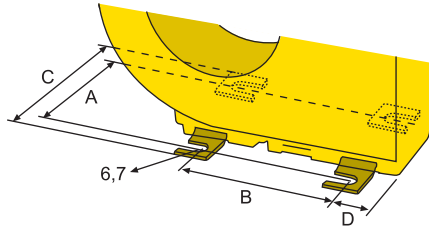

Screw mounting: W120, W210

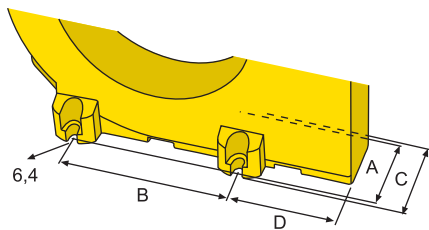

Snap-on mounting on DIN rail: for vertical or horizontal mounting: W20, W35, W60 und W20-8000, W35-8000, W60-8000

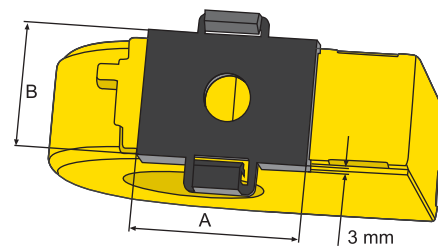
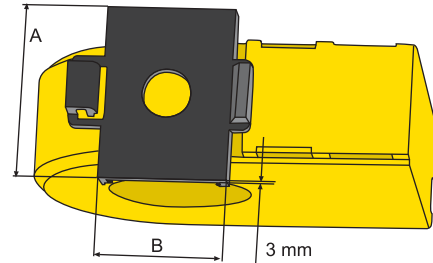

Dimensions screw mounting

Type	A	B	C	D
W20/W20-8000 (fixing with two mounting brackets, diagonally)	49	31.4	65	18.6
W35 / W35-8000 (fixing with two mounting brackets, diagonally)	49	49.8	65	12.1
W60 / W60-8000 (fixing with four mounting brackets)	56	66	72	17.7
W120 screw mounting	51	103	60.6	65
W210 screw mounting	59	180	68.6	83

Dimensions snap-on mounting

Type	A	B
W20 / W20-8000	43.5	32
W35 / W35-8000	43.5	32
W60 / W60-8000	50	39

Dimensions in mm

Dimensions in mm

Tolerance for screw mounting with mounting brackets: ± 1.5 mm

Selection list

Type	RCM420	RCM470	RCMS460/490	EDS460/490	EDS461/491	EDS470	EDS473	EDS474
W20	×	×	×	×	--	×	--	--
W35	×	×	×	×	--	×	--	--
W60	×	×	×	×	--	×	--	--
W120	×	×	×	×	--	×	--	--
W210	×	×	×	×	--	×	--	--
W20-8000	--	--	--	--	×	--	×	×
W35-8000	--	--	--	--	×	--	×	×
W60-8000	--	--	--	--	×	--	×	×



Bender GmbH & Co. KG

P.O. Box 1161 • 35301 Grünberg • Germany
 Londorfer Straße 65 • 35305 Grünberg • Germany
 Tel.: +49 6401 807-0 • Fax: +49 6401 807-259
 E-Mail: info@bender-de.com • www.bender-de.com